

YOUR PARTNER WORLDWIDE



EFCO

Grinding and Lapping Compound Overview



THE PREMIUM-PRODUCTS – MADE BY EFCO – MADE IN GERMANY

Contents	Page
1 Packaging unit / minimum order value	3
2 Grinding	4
2.1 Abrasives on a substrate	4
2.2 Abrasive	5
2.2.1 Abrasives with ceramic bonded hollow sphere (EFCOSIT)	6
2.3 Binder	6
2.4 Backing (for abrasive particles)	7
3 EFCO-GSS – Grinding Tools (CBN)	8
4 Lapping	9
5 Grinding- and lapping recommendation	10
6 Self-adhesive grinding rings TYPE: RI-	11
7 Self-adhesive grinding circular blanks TYPE: RO-	12
8 Self-adhesive rectangular grinding segments TYPE: RS-	13
9 Grinding sheets TYPE: BO-	14
10 Self-adhesive special grinding segments for roller guided grinding discs TYPE: SR-	15
11 Self-adhesive conical grinding segments 30° (2x15°) TYPE: KS-30-	16
12 Self-adhesive conical grinding segments 40° (2x20°) TYPE: KS-40-	17
13 Self-adhesive conical grinding segments 60° (2x30°) TYPE: KS-60-	18
14 Self-adhesive conical grinding segments 75° (2x37,5°) TYPE: KS-75- ..	19
15 Self-adhesive conical grinding segments 90° (2x45°) TYPE: KS-90-	20
16 Self-adhesive conical grinding segments 140° (2x70°) TYPE: KS-140-	21



17 Self-adhesive special conical grinding segments	TYPE: KS-	22
18 Boron carbide lapping paste	TYPE: BOR-	23
19 Lapping tools	TYPE: LW-	24
20 Conical grinding sleeve	TYPE: KH-	25
21 GSS – grinding tool with metallic binding	TYPE: GSS-	26
22 Cup grinding wheel for VSA-machines	TYPE: ST-	28



1 Packaging unit / minimum order value

Type	Packaging unit
Abrasive (Paper / Film / Cloth).....	100 pieces
Abrasive (EFCO-SIT).....	100 pieces
Grinding Sheets	1 piece
KS-6/10 grinding circular blank	Number of pieces depends on dimension and grit size
Grinding sleeve, conical.....	10 piece
Lapping paste	100g / 500g / 1000g
Lapping spindles.....	1 Set (3 pieces) / 1 Set (6 pieces)
Lapping discs smooth	1 piece
GSS – grinding spindles	1 Set (6 pieces)
GSS – grinding cups / grinding wheel / grinding cone	5 piece

- Minimum order value for all consumables is:
 - 85,- Euro (Germany)
 - 120,- Euro (Abroad)

- All standard dimensions and grains are available at short notice.
Further dimensions or grains can be supplied upon request.

Right reserved to make technical changes

08-2018

EFCO Maschinenbau GmbH – Valve repair and testing equipment

Otto-Brenner-Straße 5 – 7 • D - 52353 Düren • Phone: +49-(0)2421-989-0 • Fax: +49-(0)2421-86260

sales@efco-dueren.de • www.efco-dueren.com

Agencies in many countries

2 Grinding

Grinding is a machining process during which every grain which comes into contact with the material rips a minute chip out of the material.

According to DIN 8580, this process is a cutting process.

Grinding is used for:

- grinding tools to sharpen the cutting edges of tools, e.g. drill bits, saws, lathe tools, milling cutters, either manually or by machine.
- smoothing surfaces (metal and glass can be ground to a mirror finish, and a dimensional accuracy of 2.5 micrometres can be achieved).
- finishing of hardened surfaces, e.g. **sealing faces**, gauges, bearing faces, by means of cylindrical grinding, surface grinding, profile grinding.

Using the latest finishing methods, workpieces can be produced which are almost as **smooth and dimensionally accurate** as with lapping.

Grinding achieves higher removal rates which means that grinding is more economical.

2.1 Abrasives on a substrate

Abrasives are those grains of hard material which are used to achieve the material removal and are usually bound to grinding tools (abrasive paper).

The following basic requirements apply to all **abrasives**.

The abrasive should be:

- very hard and as tough as possible so that the material is removed from the workpiece and so that the cutting edges keep their sharpness for a reasonable length of time;
- resistant to thermal cycling so that the grain can withstand high machining temperatures as well as rapid temperature changes;
- chemically resistant so that no chemical compounds are formed which might weaken the grain, even during higher pressures and temperatures in conjunction with air, cutting oils or workpiece material.

A large part of grinding tasks during manufacturing is the machining of workpieces with abrasives on a substrate. These cover a wide range of applications which range from rough machining via fine machining to polishing.

The most important components of grinding tools are:

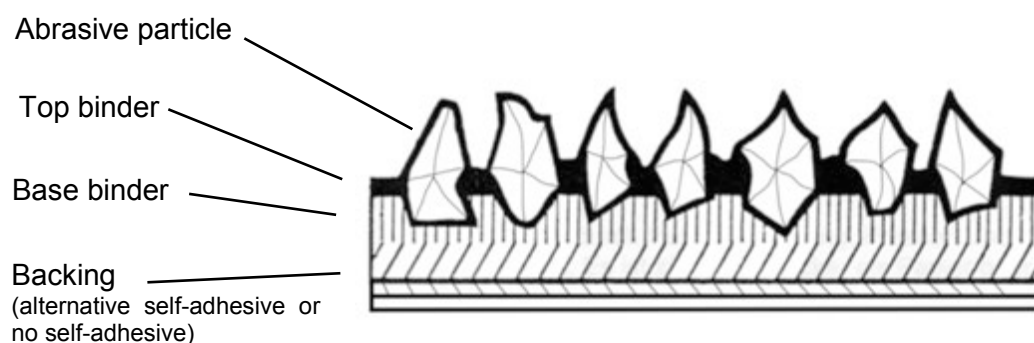

2.2 Abrasive

The abrasive is the actual cutting element.

Abrasives are distinguished with regard to size, various grain mixtures and static distribution of grain diameters according to **macro** (P 12...P 220) and **micro graining** (P 240...P1200). The letter **P** in front of the grain number shows that the grain size of abrasives on a backing is as per standard.

The letter **P** stands for **particle size**.

Particle size comparison

P	P80	P280	P500	P1000	P1200, P1500, P1800
μ	200μ	60μ	30μ	15μ	9μ

Abrasives can be divided into:

- **natural abrasives** (e.g. diamond, natural alumina, garnet, emery, quartz)
- **synthetic abrasives** (e.g. synthetic diamond, cubic crystalline boron nitride (CBN), fused alumina, zirconium oxide, silicon carbide).

Today, the synthetic abrasives, such as fused alumina, silicon carbide, zirconium oxide, cubic crystalline boron nitride and diamond, are almost the only ones of technical importance.

Aluminium oxide (Al₂O₃):

A very tough synthetic mineral of high strength.
The ideal abrasive particle for almost all grinding tasks.



Silicon carbide (SiC):

A particularly hard synthetic abrasive particle with a very high cutting efficiency.
Particularly well suited for cast iron, non-iron metals, paints, glass, plastics, porcelain and vulcanite.



Zirconium oxide (ZrO₂):

An extremely hard synthetic abrasive particle with high compressive strength for all grinding work which requires large chip removal (steel, titanium).



2.2.1 Abrasives with ceramic bonded hollow sphere (EFCOSIT)

Synthetic resin bonded grinding belt with ceramically bonded hollow spheres on a heavy polyester cloth backing (particularly tear resistant).

The hollow spheres which break up and are thus self-sharpening provide a longer tool life compared to comparable abrasives of the same grain size.

Chips flow away more easily. The abrasive surface does not clog so that a uniform surface roughness is obtained.

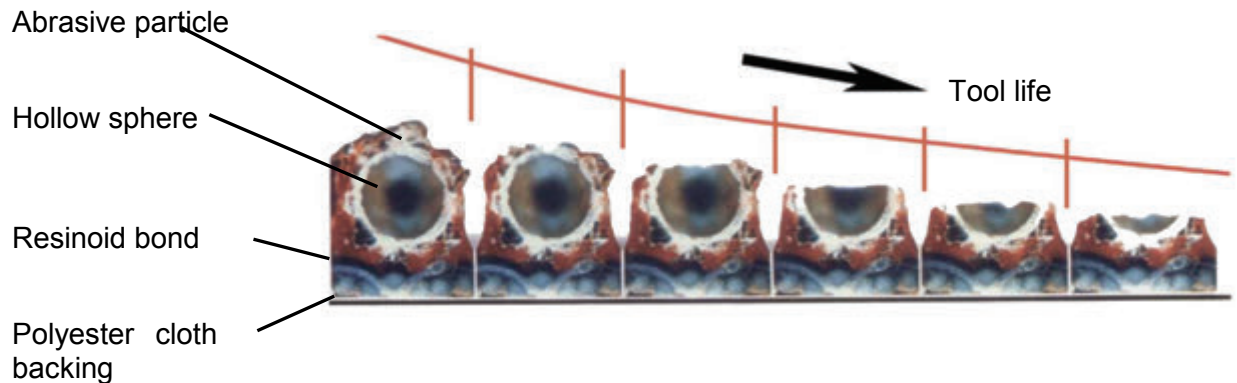

2.3 Binder

Binders for abrasives must hold the abrasive grains on the backing up to the end of the tool life. As a rule, two binder layers are required for this.

The **base binder** fixes the abrasive particles distributed over the backing in their position.

The **top binder** which is then applied provides safe support of the abrasive particles.

Natural glues, synthetic resins and varnishes are used for this purpose.

2.4 Backing (for abrasive particles)

The backing is a flexible substrate to which the abrasive particles are anchored. The backing material which is used for the abrasives features various characteristics like elasticity, flexibility and tightness. Distinguish between the following backing material:



Paper (self-adhesive *)

Paper with different surface weights is normally used as backing. Paper with a special waterproof impregnation is used for wet grinding. Thin paper is generally suitable for manual grinding, and thicker paper is required for mechanical grinding. Paper is the most widely used backing because it meets requirements in the majority of usage cases. Grinding materials with paper backing have a good price/performance ratio.

Cloth / linen (self-adhesive * or no self-adhesive)

In cases where greater demands are made of the strength and flexibility of the grinding material, backing made from cotton, polyester or blended cloth can be used. Cloth backing is more durable than paper and provides better tear resistance and extremely good elasticity. These abrasive grit carriers can be either non-waterproof or waterproofed by means of impregnation. A distinction is made between light/flexible cloth, heavy cloth with good tear resistance and average flexibility, and cloth with an extremely heavy and stable backing.

Film (self-adhesive *)

Plastic film provides extremely consistent material thickness and water resistance when it used as a carrier material. A great number of grinding tasks are in the micro-finishing area, where extreme precision is required (when grinding **safety valves**, for example). The “hard” backing provides a uniform finish.

* temperature-resistant und waterproof

3 EFCO-GSS – Grinding Tools (CBN)

The EFCO GSS grinding tools are coated with cubic crystalline boron nitride (CBN) of grain size B252 with a galvanic bond.

CBN – cubic crystalline boron nitride

CBN is highly suitable for the machining of long-chipping materials, such as **tool steel, HSS, high-alloy steels etc., hardened to at least 45 HRC.**

The good thermal stability of CBN in combination with its high hardness is what makes economical grinding at the higher machining temperatures of these steels possible.



CBN as an abrasive is distinguished in particular by:

- thermally stable up to about 600°C (1112°F)
- resistant against chemicals, steam and other aggressive media
- grinds stellites, steels, cast iron and bronze aggressively
- excellent for the removal of scale layer
- consistent machining over the whole tool life
- can also be used on hard faced sealing faces

Galvanic bond

The abrasive CBN particle is bonded to a nickel layer which has been bonded to the carrier using a galvanic process.

This bond is very open, grinds very aggressively and is suitable for the grinding of steel, carbide, plastics, etc., if the correct grain size is chosen.

The galvanic bond is generally applied in a single layer, i.e. the thickness of the layer corresponds approximately to the grain size and can thus not be dressed or re-profiled on wear.

4 Lapping

Lapping is a machining process to **smooth surfaces** whilst maintaining close tolerances and flatness.

An abrasive embedded in a lubricant is used for lapping. In contrast to grinding where the abrasive is anchored to the backing material lapping works with a moving (rolling) grain.

DIN 8589 divides lapping into two groups:

- Lapping with lapping paste
- Lapping with lapping liquid



Lapping with lapping paste

Lapping plates / lapping spindles of grey iron are used for lapping.

Lapping pastes can be applied to the sealing face or lapping plate / lapping spindle constantly as required.

After lapping, sealing face and lapping plate must be degreased and cleaned to 100 %.

Lapping with lapping liquid

Selection of the correct lapping agent

- Aluminium oxide Al_2O_3
For machining semiconductor materials (e.g. silicone and germanium), light alloys and non-ferrous metals, coal, plastics, soft steel, cast iron, etc.
- Silicon carbide SiC
For the machining of grey iron, steel (soft, hardened, alloyed), stellite, ceramics, glass, plastics, titanium, carbide, etc.
- Boron carbide B_4C
For the machining of carbide, ceramics, etc.

Grain size

Guideline values for achievable roughnesses depending on the lapping powder are shown in the table on the following page. If the same lapping grain is used, hard materials have better surface characteristics than soft materials.

Lapping agent

The machining tasks are determined not only by the type of lapping powder, but also by the mixing ratio of grain to carrier.

The carrier is usually a lapping oil or a water-based agent. EFCO recommends lapping oil as carrier.



One criterion for the quality of a lapping agent (grain + carrier) is, amongst other things, its miscibility (no agglomeration, no early separation).

5 Grinding- and lapping recommendation

Recommended grinding and lapping compound	GSS (cubic boron nitride) B252	Silicon carbide (SiC) On paper self-adhesive P80, P280, P500	special fused aluminium oxide (Al ₂ O ₃) on paper self-adhesive P80, P280, P500	special fused aluminium oxide (Al ₂ O ₃) on foil self-adhesive P80, P280, P500, P1000	Semi-fused aluminium oxide (Al ₂ O ₃) on cloth P100, P280	zirconium aluminium abrasive (ZrO ₂ +Al ₂ O ₃) on cloth self-adhesive P80	EFCOSIT (Al ₂ O ₃) corundum hollow balls on cloth self-adhesive P120	EFCOBOR (lapping paste) P80, P120, P220, P400, P800, P1000, P1200, P1500
Material to be machined, Valves to be machined								
Ordinary steel, unalloyed and alloyed (unexpired))	-	0	+	+	+	+	0	0
Iron / cast iron	0	+	+	+	+	+	0	+
Bronze, red bronze, brass	-	0	+	+	+	+	0	0
Cobalt hard-facing (Stellite)	++	+	+	+	0	+	0	+
Nickel hard-facing	++	+	+	+	0	+	0	+
Tempered steel, tool steel over 45 HRC, high-speed steel	++	+	+	+	0	+	0	+
Chrome- and chrome-nickel steel (rust-resistant steel) heat resistant nickel-alloy	-	0	+	+	0	+	+	0
Safety valves (for highest precision and even surfaces)	-	0	0	+	0	0	-	+
Hot valves (for the use with high temperatures)	++	-	-	-	0	0	0	0
Strong tender	++	+	0	0	0	0	0	0

- ++ = optimal
- + = particularly suitable
- 0 = partially suitable
- = non suitable

6 Self-adhesive grinding rings **TYPE: RI-**





R I N G S					
	Film (F)	Paper (P)	Paper (P)	Cloth (G)	Cloth (G)
	- Special fused aluminium oxide (AL) Al ₂ O ₃ - Available in grains (X): P80, 280, 500, 1000, 1800	- Silicon carbide (SIC) SiC - Available in grains (X): P80, 280, 500	- Special fused aluminium oxide (AL) Al ₂ O ₃ - Available in grains (X): P80, 280, 500	- Zircon aluminium (ZR) ZrO ₂ + Al ₂ O ₃ - Available in grains (X): P80	- EFCOSIT (SIT) Special fused aluminium oxide Al ₂ O ₃ - Available in grains (X): P120
Outer-Ø (mm)	Type				
20	RI-020-F-AL-X	RI-020-P-SIC-X	RI-020-P-AL-X	RI-020-G-ZR-X	
25	RI-025-F-AL-X	RI-025-P-SIC-X	RI-025-P-AL-X	RI-025-G-ZR-X	
30	RI-030-F-AL-X	RI-030-P-SIC-X	RI-030-P-AL-X	RI-030-G-ZR-X	RI-030-G-SIT-X
35	RI-035-F-AL-X	RI-035-P-SIC-X	RI-035-P-AL-X	RI-035-G-ZR-X	
40	RI-040-F-AL-X	RI-040-P-SIC-X	RI-040-P-AL-X	RI-040-G-ZR-X	RI-040-G-SIT-X
45	RI-045-F-AL-X	RI-045-P-SIC-X	RI-045-P-AL-X	RI-045-G-ZR-X	
50	RI-050-F-AL-X	RI-050-P-SIC-X	RI-050-P-AL-X	RI-050-G-ZR-X	RI-050-G-SIT-X
55	RI-055-F-AL-X	RI-055-P-SIC-X	RI-055-P-AL-X	RI-055-G-ZR-X	
60	RI-060-F-AL-X	RI-060-P-SIC-X	RI-060-P-AL-X	RI-060-G-ZR-X	RI-060-G-SIT-X
65	RI-065-F-AL-X	RI-065-P-SIC-X	RI-065-P-AL-X	RI-065-G-ZR-X	
73	RI-073-F-AL-X	RI-073-P-SIC-X	RI-073-P-AL-X	RI-073-G-ZR-X	
80	RI-080-F-AL-X	RI-080-P-SIC-X	RI-080-P-AL-X	RI-080-G-ZR-X	RI-080-G-SIT-X
85	RI-085-F-AL-X	RI-085-P-SIC-X	RI-085-P-AL-X	RI-085-G-ZR-X	
90	RI-090-F-AL-X	RI-090-P-SIC-X	RI-090-P-AL-X	RI-090-G-ZR-X	RI-090-G-SIT-X
95	RI-095-F-AL-X	RI-095-P-SIC-X	RI-095-P-AL-X	RI-095-G-ZR-X	
100	RI-100-F-AL-X	RI-100-P-SIC-X	RI-100-P-AL-X	RI-100-G-ZR-X	RI-100-G-SIT-X
105	RI-105-F-AL-X	RI-105-P-SIC-X	RI-105-P-AL-X	RI-105-G-ZR-X	
110	RI-110-F-AL-X	RI-110-P-SIC-X	RI-110-P-AL-X	RI-110-G-ZR-X	RI-110-G-SIT-X
115	RI-115-F-AL-X	RI-115-P-SIC-X	RI-115-P-AL-X	RI-115-G-ZR-X	
120	RI-120-F-AL-X	RI-120-P-SIC-X	RI-120-P-AL-X	RI-120-G-ZR-X	RI-120-G-SIT-X
125	RI-125-F-AL-X	RI-125-P-SIC-X	RI-125-P-AL-X	RI-125-G-ZR-X	
140	RI-140-F-AL-X	RI-140-P-SIC-X	RI-140-P-AL-X	RI-140-G-ZR-X	
150	RI-150-F-AL-X	RI-150-P-SIC-X	RI-150-P-AL-X	RI-150-G-ZR-X	
165	RI-165-F-AL-X	RI-165-P-SIC-X	RI-165-P-AL-X	RI-165-G-ZR-X	
175	RI-175-F-AL-X	RI-175-P-SIC-X	RI-175-P-AL-X	RI-175-G-ZR-X	

Other grains available on request

Ordering example:

Self-adhesive film grinding ring Ø80 mm in special fused aluminium oxide (Al₂O₃) / grain P280
➔ RI-080-F-AL-0280

7 Self-adhesive grinding circular blanks **TYPE: RO-**

C I R C U L A R	B L A N K S				
		Film (F)	Paper (P)	Paper (P)	Cloth (G)
		- Special fused aluminium oxide (AL) Al ₂ O ₃ - Available in grains (X): P80, 280, 500, 1000, 1800	- Silicon carbide (SIC) SiC - Available in grains (X): P80, 280, 500	- Special fused aluminium oxide (AL) Al ₂ O ₃ - Available in grains (X): P80, 280, 500	- Zircon aluminium (ZR) ZrO ₂ + Al ₂ O ₃ - Available in grains (X): P80
Outer-Ø (mm)	Type				
18	RO-0018-F-AL-X	RO-0018-P-SIC-X	RO-0018-P-AL-X	RO-0018-G-ZR-X	
26	RO-0026-F-AL-X	RO-0026-P-SIC-X	RO-0026-P-AL-X	RO-0026-G-ZR-X	
29	RO-0029-F-AL-X	RO-0029-P-SIC-X	RO-0029-P-AL-X	RO-0029-G-ZR-X	
34	RO-0034-F-AL-X	RO-0034-P-SIC-X	RO-0034-P-AL-X	RO-0034-G-ZR-X	
50	RO-0050-F-AL-X	RO-0050-P-SIC-X	RO-0050-P-AL-X	RO-0050-G-ZR-X	
63	RO-0063-F-AL-X	RO-0063-P-SIC-X	RO-0063-P-AL-X	RO-0063-G-ZR-X	

	Film (F)	Paper (P)	Paper (P)	Cloth (G)
	- Special fused aluminium oxide (AL) Al ₂ O ₃ - Available in grains (X): P80	- Silicon carbide (SIC) SiC - Available in grains (X): P80, 280, 500	- Special fused aluminium oxide (AL) Al ₂ O ₃ - Available in grains (X): P80, 280, 500	- Zircon aluminium (ZR) ZrO ₂ + Al ₂ O ₃ - Available in grains (X): P80
Outer-Ø (mm)	Type			
600	RO-0600-F-AL-X	RO-0600-P-SIC-X	RO-0600-P-AL-X	*◆ RO-0600-G-ZR-X
1000			*◆ RO-1000-P-AL-X	

Other grains available on request

* = Minimum order quantity 25 pieces





◆ = Not available from stock

Ordering example:

Self-adhesive film grinding circular blank Ø50 mm in special fused aluminium oxide (Al₂O₃) / grain P280

➔ **RO-0050-F-AL-0280**

8 Self-adhesive rectangular grinding segments **TYPE: RS-**

R E C T A N G U L A R S E G M E N T S				
	Film (F)	Paper (P)	Paper (P)	Cloth (G)
	- Special fused aluminium oxide (AL) Al ₂ O ₃ - Available in grains (X): P80, 280, 500, 1000, 1800	- Silicon carbide (SIC) SiC - Available in grains (X): P80, 280, 500	- Special fused aluminium oxide (AL) Al ₂ O ₃ - Available in grains (X): P80, 280, 500	- Zircon aluminium (ZR) ZrO ₂ + Al ₂ O ₃ - Available in grains (X): P80
Dimensions (mm)	Type			
20x20	RS-020x020-F-AL-X	RS-020x020-P-SIC-X	RS-020x020-P-AL-X	RS-020x020-G-ZR-X
30x20	RS-030x020-F-AL-X	RS-030x020-P-SIC-X	RS-030x020-P-AL-X	RS-030x020-G-ZR-X
35x20	RS-035x020-F-AL-X	RS-035x020-P-SIC-X	RS-035x020-P-AL-X	RS-035x020-G-ZR-X
35x30	RS-035x030-F-AL-X	RS-035x030-P-SIC-X	RS-035x030-P-AL-X	RS-035x030-G-ZR-X
50x50	RS-050x050-F-AL-X	RS-050x050-P-SIC-X	RS-050x050-P-AL-X	RS-050x050-G-ZR-X
55x30	RS-055x030-F-AL-X	RS-055x030-P-SIC-X	RS-055x030-P-AL-X	RS-055x030-G-ZR-X
60x40	RS-060x040-F-AL-X	RS-060x040-P-SIC-X	RS-060x040-P-AL-X	RS-060x040-G-ZR-X
70x45	RS-070x045-F-AL-X	RS-070x045-P-SIC-X	RS-070x045-P-AL-X	RS-070x045-G-ZR-X
110x20	RS-110x020-F-AL-X	RS-110x020-P-SIC-X	RS-110x020-P-AL-X	RS-110x020-G-ZR-X
130x20	RS-130x020-F-AL-X	RS-130x020-P-SIC-X	RS-130x020-P-AL-X	RS-130x020-G-ZR-X
155x20	RS-155x020-F-AL-X	RS-155x020-P-SIC-X	RS-155x020-P-AL-X	RS-155x020-G-ZR-X
220x25	RS-220x025-F-AL-X	RS-220x025-P-SIC-X	RS-220x025-P-AL-X	RS-220x025-G-ZR-X



Other grains available on request



Ordering example:

Self-adhesive rectangular film grinding segments 35x30 mm in special fused aluminium oxide (Al₂O₃) / grain P280

➔ **RS-035x030-F-AL-0280**

9 Grinding sheets **TYPE: BO-**

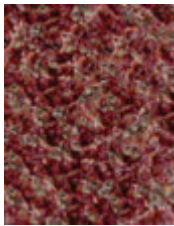
S H E E T S			
	Film (F)	Paper (P)	Paper (P)
	self-adhesive	self-adhesive	self-adhesive
	- Special fused aluminium oxide (AL) Al ₂ O ₃ - Available in grains (X): P80, 280, 500, 1000, 1800	- Silicon carbide (SIC) SiC - Available in grains (X): P80, 280, 500	- Special fused aluminium oxide (AL) Al ₂ O ₃ - Available in grains (X): P80, 280, 500
Dimensions (mm)	Type		
300x350	BO-300x350-F-AL-X	BO-300x350-P-SIC-X	BO-300x350-P-AL-X
600x600	BO-600x600-F-AL-X (not available in grain P280 / P500 / P1000 / P1800)	*♦ BO-600x600-P-SIC-X	*♦ BO-600x600-P-AL-X

			
	Cloth (G)	Cloth (G)	Cloth (G)
	self-adhesive	self-adhesive	no self-adhesive
	- Zircon aluminium (ZR) ZrO ₂ + Al ₂ O ₃ - Available in grains (X): P80	- EFCOSIT (SIT) Special fused aluminium oxide Al ₂ O ₃ - Available in grains (X): P120	- Special fused aluminium oxide (AL) Al ₂ O ₃ - Available in grains (X): P100, 280
Dimensions (mm)	Type		
300x350	BO-300x350-G-ZR-X	BO-300x350-G-SIT-X	BO-300x350-G-AL-X
600x600	*♦ BO-600x600-G-ZR-X	*♦ BO-600x600-G-SIT -X	*♦ BO-600x600-G-AL-X

Other grains available on request

* = Minimum order quantity 25 pieces





♦ = Not available from stock

Ordering example:

Self-adhesive film grinding sheet 300x350 mm in special fused aluminium oxide (Al₂O₃) / grain P280

➔ **BO-300x350-F-AL-0280**

10 Self-adhesive special grinding segments for roller guided grinding discs TYPE: SR-

				
	<p>Film (F)</p> <p>- Special fused aluminium oxide (AL) Al_2O_3</p> <p>- Available in grains (X): P80, 280, 500, 1000, 1800</p>	<p>Paper (P)</p> <p>- Silicon carbide (SIC) SiC</p> <p>- Available in grains (X): P80, 280, 500</p>	<p>Paper (P)</p> <p>- Special fused aluminium oxide (AL) Al_2O_3</p> <p>- Available in grains (X): P80, 280, 500</p>	<p>Cloth (G)</p> <p>- Zircon aluminium (ZR) $ZrO_2 + Al_2O_3$</p> <p>- Available in grains (X): P80</p>
<p>A x H (mm)</p>	<p>Type</p>			
51 x 30 *	SR-51x30-F-AL-X	SR-51x30-P-SIC-X	SR-51x30-P-AL-X	SR-51x30-G-ZR-X
59 x 32 **	SR-59x32-F-AL-X	SR-59x32-P-SIC-X	SR-59x32-P-AL-X	SR-59x32-G-ZR-X
47 x 35 ***	SR-47x35-F-AL-X	SR-47x35-P-SIC-X	SR-47x35-P-AL-X	SR-47x35-G-ZR-X

Other grains available on request

- * for grinding disc \varnothing 95 mm
- ** for grinding disc \varnothing 115 mm
- *** for grinding disc \varnothing 140-355 mm

Ordering example:

Self-adhesive special film grinding segments 51x30 mm in special fused aluminium oxide (Al_2O_3) / grain P280

➔ **SR-51x30-F-AL-0280**

11 Self-adhesive conical grinding segments 30° (2x15°) **TYPE: KS-30-**

CONICAL SEGMENTS					
	Film (F)	Paper (P)	Paper (P)	Cloth (G)	Cloth (G)
	self-adhesive	self-adhesive	self-adhesive	self-adhesive	no self-adhesive
	- Special fused aluminium oxide (AL) Al ₂ O ₃ - Available in grains (X): P80, 280, 500, 1000, 1800	- Silicon carbide (SIC) SiC - Available in grains (X): P80, 280, 500	- Special fused aluminium oxide (AL) Al ₂ O ₃ - Available in grains (X): P80, 280, 500	- Zircon aluminium (ZR) ZrO ₂ + Al ₂ O ₃ - Available in grains (X): P80	- Special fused aluminium oxide (AL) Al ₂ O ₃ - Available in grains (X): P100, 280
Ø D (mm)	Type				
72 ◎ ○	KS-30-072-F-AL-X	KS-30-072-P-SIC-X	KS-30-072-P-AL-X	KS-30-072-G-ZR-X	KS-30-072-G-AL-X
101 ○	KS-30-101-F-AL-X	KS-30-101-P-SIC-X	KS-30-101-P-AL-X	KS-30-101-G-ZR-X	
105 ◎	KS-30-105-F-AL-X	KS-30-105-P-SIC-X	KS-30-105-P-AL-X	KS-30-105-G-ZR-X	KS-30-105-G-AL-X
124 ○	KS-30-124-F-AL-X	KS-30-124-P-SIC-X	KS-30-124-P-AL-X	KS-30-124-G-ZR-X	
160 ◎	KS-30-160-F-AL-X	KS-30-160-P-SIC-X	KS-30-160-P-AL-X	KS-30-160-G-ZR-X	KS-30-160-G-AL-X
169 ○	KS-30-169-F-AL-X	KS-30-169-P-SIC-X	KS-30-169-P-AL-X	KS-30-169-G-ZR-X	
213 ◎	KS-30-213-F-AL-X	KS-30-213-P-SIC-X	KS-30-213-P-AL-X	KS-30-213-G-ZR-X	KS-30-213-G-AL-X
223 ○	KS-30-223-F-AL-X	KS-30-223-P-SIC-X	KS-30-223-P-AL-X	KS-30-223-G-ZR-X	
224 ◎	KS-30-224-F-AL-X	KS-30-224-P-SIC-X	KS-30-224-P-AL-X	KS-30-224-G-ZR-X	KS-30-224-G-AL-X
280 ○	KS-30-280-F-AL-X	KS-30-280-P-SIC-X	KS-30-280-P-AL-X	KS-30-280-G-ZR-X	
290 ◎	KS-30-290-F-AL-X	KS-30-290-P-SIC-X	KS-30-290-P-AL-X	KS-30-290-G-ZR-X	KS-30-290-G-AL-X
346 ◎	KS-30-346-F-AL-X	KS-30-346-P-SIC-X	KS-30-346-P-AL-X	KS-30-346-G-ZR-X	KS-30-346-G-AL-X

Other grains available on request

◎ = for VSK Europe-Version

○ = for VSK USA-Version

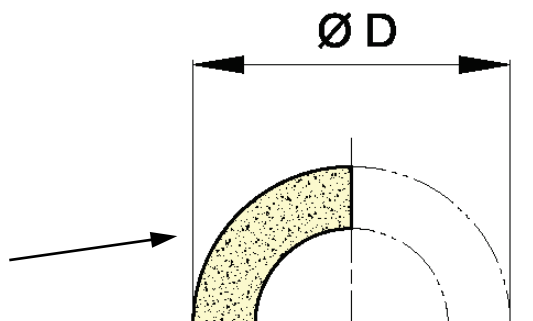

Ordering example:

Self-adhesive conical film grinding segments 30° / Ø160 mm in special fused aluminium oxide (Al₂O₃) / grain P280

➔ **KS-30-160-F-AL-0280**

12 Self-adhesive conical grinding segments 40° (2x20°) **TYPE: KS-40-**

CONICAL SEGMENTS					
	Film (F)	Paper (P)	Paper (P)	Cloth (G)	Cloth (G)
	self-adhesive	self-adhesive	self-adhesive	self-adhesive	no self-adhesive
	- Special fused aluminium oxide (AL) Al ₂ O ₃ - Available in grains (X): P80, 280, 500, 1000, 1800	- Silicon carbide (SIC) SiC - Available in grains (X): P80, 280, 500	- Special fused aluminium oxide (AL) Al ₂ O ₃ - Available in grains (X): P80, 280, 500	- Zircon aluminium (ZR) ZrO ₂ + Al ₂ O ₃ - Available in grains (X): P80	- Special fused aluminium oxide (AL) Al ₂ O ₃ - Available in grains (X): P100, 280
Ø D (mm)	Type				
69 ⊙ ⊙	KS-40-069-F-AL-X	KS-40-069-P-SIC-X	KS-40-069-P-AL-X	KS-40-069-G-ZR-X	KS-40-069-G-AL-X
94 ⊙ ⊙	KS-40-094-F-AL-X	KS-40-094-P-SIC-X	KS-40-094-P-AL-X	KS-40-094-G-ZR-X	KS-40-094-G-AL-X
112 ⊙	KS-40-112-F-AL-X	KS-40-112-P-SIC-X	KS-40-112-P-AL-X	KS-40-112-G-ZR-X	KS-40-112-G-AL-X
124 ⊙	KS-40-124-F-AL-X	KS-40-124-P-SIC-X	KS-40-124-P-AL-X	KS-40-124-G-ZR-X	KS-40-124-G-AL-X
134 ⊙ ⊙	KS-40-134-F-AL-X	KS-40-134-P-SIC-X	KS-40-134-P-AL-X	KS-40-134-G-ZR-X	KS-40-134-G-AL-X
158 ⊙	KS-40-158-F-AL-X	KS-40-158-P-SIC-X	KS-40-158-P-AL-X	KS-40-158-G-ZR-X	KS-40-158-G-AL-X
175 ⊙ ⊙	KS-40-175-F-AL-X	KS-40-175-P-SIC-X	KS-40-175-P-AL-X	KS-40-175-G-ZR-X	KS-40-175-G-AL-X
219 ⊙	KS-40-219-F-AL-X	KS-40-219-P-SIC-X	KS-40-219-P-AL-X	KS-40-219-G-ZR-X	KS-40-219-G-AL-X
263 ⊙	KS-40-263-F-AL-X	KS-40-263-P-SIC-X	KS-40-263-P-AL-X	KS-40-263-G-ZR-X	KS-40-263-G-AL-X

Other grains available on request

⊙ = for VSK Europe-Version ● = for VSK USA-Version

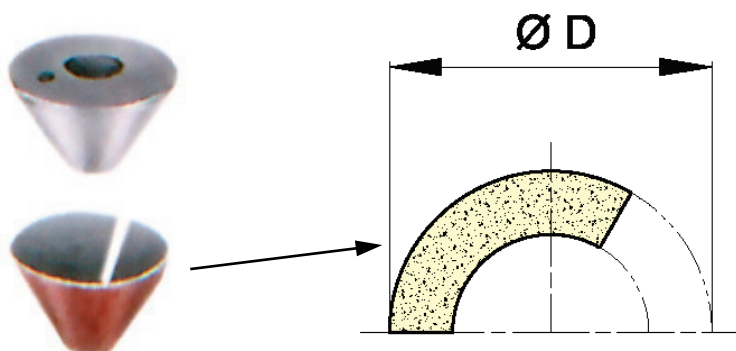

Ordering example:

Self-adhesive conical film grinding segments 40° / Ø94 mm in special fused aluminium oxide (Al₂O₃) / grain P280

➔ **KS-40-094-F-AL-0280**

13 Self-adhesive conical grinding segments 60° (2x30°) **TYPE: KS-60-**

CONICAL SEGMENTS					
	Film (F)	Paper (P)	Paper (P)	Cloth (G)	Cloth (G)
	self-adhesive	self-adhesive	self-adhesive	self-adhesive	no self-adhesive
	- Special fused aluminium oxide (AL) Al ₂ O ₃ - Available in grains (X): P80, 280, 500, 1000, 1800	- Silicon carbide (SIC) SiC - Available in grains (X): P80, 280, 500	- Special fused aluminium oxide (AL) Al ₂ O ₃ - Available in grains (X): P80, 280, 500	- Zircon aluminium (ZR) ZrO ₂ + Al ₂ O ₃ - Available in grains (X): P80	- Special fused aluminium oxide (AL) Al ₂ O ₃ - Available in grains (X): P100, 280
Ø D (mm)	Type				
27	KS-60-027-F-AL-X	KS-60-027-P-SIC-X	KS-60-027-P-AL-X	KS-60-027-G-ZR-X	KS-60-027-G-AL-X
32	KS-60-032-F-AL-X	KS-60-032-P-SIC-X	KS-60-032-P-AL-X	KS-60-032-G-ZR-X	KS-60-032-G-AL-X
40	KS-60-040-F-AL-X	KS-60-040-P-SIC-X	KS-60-040-P-AL-X	KS-60-040-G-ZR-X	KS-60-040-G-AL-X
52	KS-60-052-F-AL-X	KS-60-052-P-SIC-X	KS-60-052-P-AL-X	KS-60-052-G-ZR-X	KS-60-052-G-AL-X
60	KS-60-060-F-AL-X	KS-60-060-P-SIC-X	KS-60-060-P-AL-X	KS-60-060-G-ZR-X	KS-60-060-G-AL-X
75	KS-60-075-F-AL-X	KS-60-075-P-SIC-X	KS-60-075-P-AL-X	KS-60-075-G-ZR-X	KS-60-075-G-AL-X
82	KS-60-082-F-AL-X	KS-60-082-P-SIC-X	KS-60-082-P-AL-X	KS-60-082-G-ZR-X	KS-60-082-G-AL-X
90	KS-60-090-F-AL-X	KS-60-090-P-SIC-X	KS-60-090-P-AL-X	KS-60-090-G-ZR-X	KS-60-090-G-AL-X
98	KS-60-098-F-AL-X	KS-60-098-P-SIC-X	KS-60-098-P-AL-X	KS-60-098-G-ZR-X	
110	KS-60-110-F-AL-X	KS-60-110-P-SIC-X	KS-60-110-P-AL-X	KS-60-110-G-ZR-X	KS-60-110-G-AL-X
120	KS-60-120-F-AL-X	KS-60-120-P-SIC-X	KS-60-120-P-AL-X	KS-60-120-G-ZR-X	KS-60-120-G-AL-X
144	KS-60-144-F-AL-X	KS-60-144-P-SIC-X	KS-60-144-P-AL-X	KS-60-144-G-ZR-X	
150	KS-60-150-F-AL-X	KS-60-150-P-SIC-X	KS-60-150-P-AL-X	KS-60-150-G-ZR-X	KS-60-150-G-AL-X
184	KS-60-184-F-AL-X	KS-60-184-P-SIC-X	KS-60-184-P-AL-X	KS-60-184-G-ZR-X	KS-60-184-G-AL-X

Other grains available on request

⊙ = for VSK Europe-Version

● = for VSK USA-Version

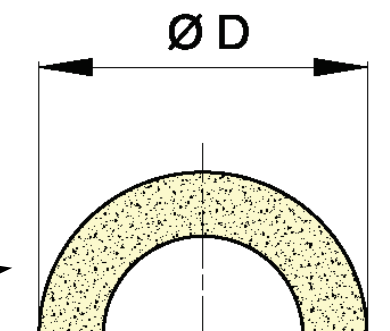

Ordering example:

Self-adhesive conical film grinding segments 60° / Ø120 mm in special fused aluminium oxide (Al₂O₃) / grain P280

➔ **KS-60-120-F-AL-0280**

14 Self-adhesive conical grinding segments 75° (2x37,5°) **TYPE: KS-75-**

CONICAL SEGMENTS					
	Film (F)	Paper (P)	Paper (P)	Cloth (G)	Cloth (G)
	self-adhesive	self-adhesive	self-adhesive	self-adhesive	no self-adhesive
	- Special fused aluminium oxide (AL) Al ₂ O ₃	- Silicon carbide (SIC) SiC	- Special fused aluminium oxide (AL) Al ₂ O ₃	- Zircon aluminium (ZR) ZrO ₂ + Al ₂ O ₃	- Special fused aluminium oxide (AL) Al ₂ O ₃
	- Available in grains (X): P80, 280, 500, 1000, 1800	- Available in grains (X): P80, 280, 500	- Available in grains (X): P80, 280, 500	- Available in grains (X): P80	- Available in grains (X): P100, 280
Ø D (mm)	Type				
28 ◎ ○	KS-75-028-F-AL-X	KS-75-028-P-SIC-X	KS-75-028-P-AL-X	KS-75-028-G-ZR-X	KS-75-028-G-AL-X
40 ◎ ○	KS-75-040-F-AL-X	KS-75-040-P-SIC-X	KS-75-040-P-AL-X	KS-75-040-G-ZR-X	KS-75-040-G-AL-X
50 ◎ ○	KS-75-050-F-AL-X	KS-75-050-P-SIC-X	KS-75-050-P-AL-X	KS-75-050-G-ZR-X	KS-75-050-G-AL-X
63 ◎ ○	KS-75-063-F-AL-X	KS-75-063-P-SIC-X	KS-75-063-P-AL-X	KS-75-063-G-ZR-X	KS-75-063-G-AL-X
95 ◎ ○	KS-75-095-F-AL-X	KS-75-095-P-SIC-X	KS-75-095-P-AL-X	KS-75-095-G-ZR-X	KS-75-095-G-AL-X
124 ◎ ○	KS-75-124-F-AL-X	KS-75-124-P-SIC-X	KS-75-124-P-AL-X	KS-75-124-G-ZR-X	KS-75-124-G-AL-X
150 ◎ ○	KS-75-150-F-AL-X	KS-75-150-P-SIC-X	KS-75-150-P-AL-X	KS-75-150-G-ZR-X	KS-75-150-G-AL-X

Other grains available on request

◎ = for VSK Europe-Version

○ = for VSK USA-Version

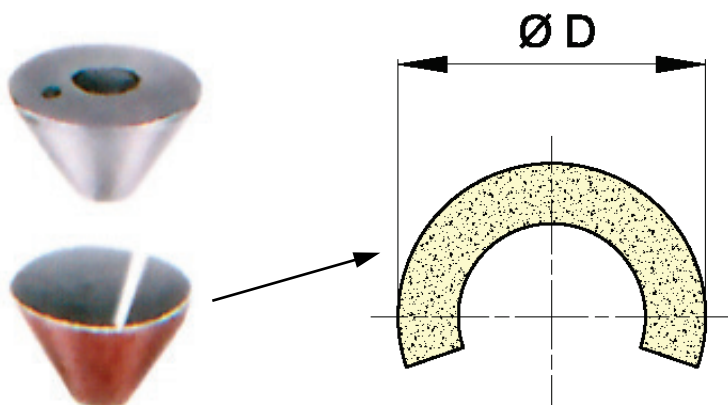

Ordering example:

Self-adhesive conical film grinding segments 75° / Ø95 mm in special fused aluminium oxide (Al₂O₃) / grain P280

➔ **KS-75-095-F-AL-0280**

15 Self-adhesive conical grinding segments 90° (2x45°) **TYPE: KS-90-**

CONICAL SEGMENTS					
	Film (F)	Paper (P)	Paper (P)	Cloth (G)	Cloth (G)
	self-adhesive	self-adhesive	self-adhesive	self-adhesive	no self-adhesive
	- Special fused aluminium oxide (AL) Al ₂ O ₃	- Silicon carbide (SIC) SiC	- Special fused aluminium oxide (AL) Al ₂ O ₃	- Zircon aluminium (ZR) ZrO ₂ + Al ₂ O ₃	- Special fused aluminium oxide (AL) Al ₂ O ₃
	- Available in grains (X): P80, 280, 500, 1000, 1800	- Available in grains (X): P80, 280, 500	- Available in grains (X): P80, 280, 500	- Available in grains (X): P80	- Available in grains (X): P100, 280
Ø D (mm)	Type				
27 ◎	KS-90-027-F-AL-X	KS-90-027-P-SIC-X	KS-90-027-P-AL-X	KS-90-027-G-ZR-X	KS-90-027-G-AL-X
36 ◎ ●	KS-90-036-F-AL-X	KS-90-036-P-SIC-X	KS-90-036-P-AL-X	KS-90-036-G-ZR-X	KS-90-036-G-AL-X
45 ◎ ●	KS-90-045-F-AL-X	KS-90-045-P-SIC-X	KS-90-045-P-AL-X	KS-90-045-G-ZR-X	KS-90-045-G-AL-X
54 ◎ ●	KS-90-054-F-AL-X	KS-90-054-P-SIC-X	KS-90-054-P-AL-X	KS-90-054-G-ZR-X	KS-90-054-G-AL-X
67 ◎ ●	KS-90-067-F-AL-X	KS-90-067-P-SIC-X	KS-90-067-P-AL-X	KS-90-067-G-ZR-X	KS-90-067-G-AL-X
85 ◎ ●	KS-90-085-F-AL-X	KS-90-085-P-SIC-X	KS-90-085-P-AL-X	KS-90-085-G-ZR-X	KS-90-085-G-AL-X
112 ◎ ●	KS-90-112-F-AL-X	KS-90-112-P-SIC-X	KS-90-112-P-AL-X	KS-90-112-G-ZR-X	KS-90-112-G-AL-X
138 ◎	KS-90-138-F-AL-X	KS-90-138-P-SIC-X	KS-90-138-P-AL-X	KS-90-138-G-ZR-X	KS-90-138-G-AL-X

Other grains available on request

◎ = for VSK Europe-Version

● = for VSK USA-Version

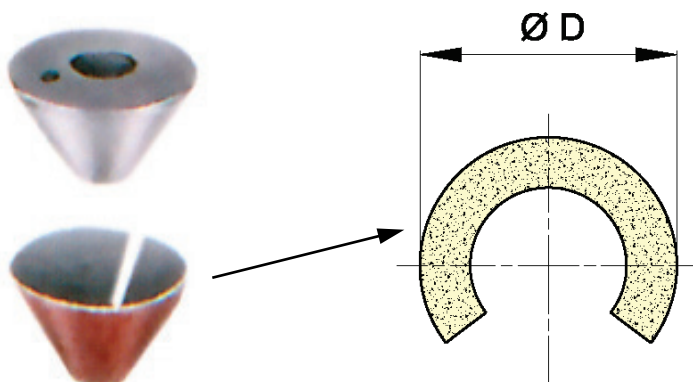

Ordering example:

Self-adhesive conical film grinding segments 90° / Ø67 mm in special fused aluminium oxide (Al₂O₃) / grain P280

➔ **KS-90-067-F-AL-0280**

16 Self-adhesive conical grinding segments 140° (2x70°) **TYPE: KS-140-**

CONICAL SEGMENTS					
	Film (F)	Paper (P)	Paper (P)	Cloth (G)	Cloth (G)
	self-adhesive	self-adhesive	self-adhesive	self-adhesive	no self-adhesive
	- Special fused aluminium oxide (AL) Al ₂ O ₃	- Silicon carbide (SIC) SiC	- Special fused aluminium oxide (AL) Al ₂ O ₃	- Zircon aluminium (ZR) ZrO ₂ + Al ₂ O ₃	- Special fused aluminium oxide (AL) Al ₂ O ₃
	- Available in grains (X): P80, 280, 500, 1000, 1800	- Available in grains (X): P80, 280, 500	- Available in grains (X): P80, 280, 500	- Available in grains (X): P80	- Available in grains (X): P100, 280
Ø D (mm)	Type				
24	KS-140-024-F-AL-X	KS-140-024-P-SIC-X	KS-140-024-P-AL-X	KS-140-024-G-ZR-X	KS-140-024-G-AL-X
29	KS-140-029-F-AL-X	KS-140-029-P-SIC-X	KS-140-029-P-AL-X	KS-140-029-G-ZR-X	KS-140-029-G-AL-X
46	KS-140-046-F-AL-X	KS-140-046-P-SIC-X	KS-140-046-P-AL-X	KS-140-046-G-ZR-X	KS-140-046-G-AL-X
71	KS-140-071-F-AL-X	KS-140-071-P-SIC-X	KS-140-071-P-AL-X	KS-140-071-G-ZR-X	KS-140-071-G-AL-X
96	KS-140-096-F-AL-X	KS-140-096-P-SIC-X	KS-140-096-P-AL-X	KS-140-096-G-ZR-X	KS-140-096-G-AL-X
134	KS-140-134-F-AL-X	KS-140-134-P-SIC-X	KS-140-134-P-AL-X	KS-140-134-G-ZR-X	KS-140-134-G-AL-X
183	KS-140-183-F-AL-X	KS-140-183-P-SIC-X	KS-140-183-P-AL-X	KS-140-183-G-ZR-X	KS-140-183-G-AL-X

Other grains available on request

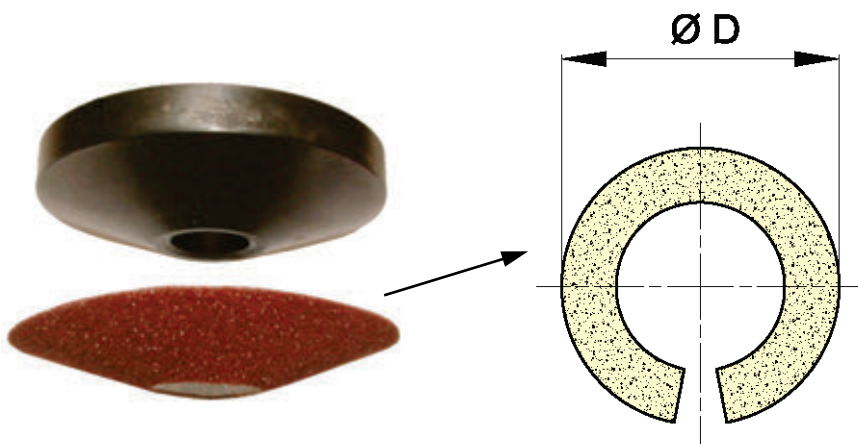





Ordering example:

Self-adhesive conical film grinding segments 140° / Ø46 mm in special fused aluminium oxide (Al₂O₃) / grain P280

➔ **KS-140-046-F-AL-0280**

17 Self-adhesive special conical grinding segments TYPE: KS-

				
	<p>Film (F)</p> <p>- Special fused aluminium oxide (AL) Al_2O_3</p> <p>- Available in grains (X): P80, 280, 500, 1000, 1800</p>	<p>Paper (P)</p> <p>- Silicon carbide (SIC) SiC</p> <p>- Available in grains (X): P80, 280, 500</p>	<p>Paper (P)</p> <p>- Special fused aluminium oxide (AL) Al_2O_3</p> <p>- Available in grains (X): P80, 280, 500</p>	<p>Cloth (G)</p> <p>- Zircon aluminium (ZR) $ZrO_2 + Al_2O_3$</p> <p>- Available in grains (X): P80</p>

Seat angle 30° (2x15°) TYP: KS-30-

A x H (mm)	Type			
36 x 43 ○	KS-30-36x43-F-AL-X	KS-30-36x43-P-SIC-X	KS-30-36x43-P-AL-X	KS-30-36x43-G-ZR-X

Seat angle 40° (2x20°) / Seat angle 60° (2x30°) TYP: KS-40/60-

A x H (mm)	Type			
40 x 23 ○	KS-40/60-40x23-F-AL-X	KS-40/60-40x23-P-SIC-X	KS-40/60-40x23-P-AL-X	KS-40/60-40x23-G-ZR-X

Seat angle 90° (2x45°) TYP: KS-90-

A x H (mm)	Type			
38 x 36 ○	KS-90-38x36-F-AL-X	KS-90-38x36-P-SIC-X	KS-90-38x36-P-AL-X	KS-90-38x36-G-ZR-X

Other grains available on request

○ = for VSK USA-Version

Ordering example:

Self-adhesive conical film grinding segments 30° / 36x43 mm in special fused aluminium oxide (Al_2O_3) / grain P280

➔ **KS-30-36x43-F-AL-0280**

18 Boron carbide lapping paste **TYPE: BOR-**



- Oil-soluble lapping paste of boron carbide

Grain size	Type		
	80	BOR-0080-0,1	BOR-0080-0,5
120	BOR-0120-0,1	BOR-0120-0,5	BOR-0120-1
220	BOR-0220-0,1	BOR-0220-0,5	BOR-0220-1
400	BOR-0400-0,1	BOR-0400-0,5	BOR-0400-1
800	BOR-0800-0,1	BOR-0800-0,5	BOR-0800-1
1000	BOR-1000-0,1	BOR-1000-0,5	BOR-1000-1
1200	BOR-1200-0,1	BOR-1200-0,5	BOR-1200-1
1500	BOR-1500-0,1	BOR-1500-0,5	BOR-1500-1

Packaging unit: 0,1 kg, 0,5 kg, 1 kg

Ordering example:

Lapping paste of boron carbide / grain P220 / 0,5kg

➔ **BOR-0220-0,5**

19 Lapping tools **TYPE: LW-**

 <p>Lapping spindle (SP1) for SL-15 / SL-2 / Valva-15 / SM</p>	Outer-Ø (mm)	1 Set (3 pieces) Type	1 Set (6 pieces) Type
	30	LW-SP1-030-S3	LW-SP1-030-S6
	50	LW-SP1-050-S3	LW-SP1-050-S6
	80	LW-SP1-080-S3	LW-SP1-080-S6
	120	LW-SP1-120-S3	LW-SP1-120-S6

 <p>Lapping spindle (SP2) for SL-3 / Valva-3</p>	Outer-Ø (mm)	1 Set (3 pieces) Type	1 Set (6 pieces) Type
	80	LW-SP2-080-S3	LW-SP2-080-S6
	120	LW-SP2-120-S3	LW-SP2-120-S6
	150	LW-SP2-150-S3	LW-SP2-150-S6

 <p>Smooth lapping disc (SCG) with different mounting holes:</p> <ul style="list-style-type: none"> • Mounting holes Ø 8 mm (A08) • Mounting holes Ø20 mm (A20) • Mounting holes Ø30 mm (A30) • Mounting holes Ø25 mm (A25) 	Outer-Ø (mm)	Type
	24	LW-SCG-A08-024
	29	LW-SCG-A08-029
	34	LW-SCG-A08-034
	39	LW-SCG-A08-039
	44	LW-SCG-A20-044
	54	LW-SCG-A20-054
	64	LW-SCG-A20-064
	79	LW-SCG-A20-079
	98	LW-SCG-A30-098
	118	LW-SCG-A30-118
	140	LW-SCG-A30-140
	165	LW-SCG-A30-165
	200	LW-SCG-A30-200
	220	LW-SCG-A30-220
	270	LW-SCG-A30-270
320	LW-SCG-A30-320	
55	LW-SCG-A25-055	
65	LW-SCG-A25-065	

20 Conical grinding sleeve **TYPE: KH-**



		Type	
		Special fused aluminium oxide (AL) Al ₂ O ₃ - Available in grains (X): P40, 100, 280	Silicon carbide (SIC) SiC - Available in grains (X): P40 [◆] , 100 [◆] , 280 [◆] , 400
TYPE I (2x45°) / Ø40	✕	*KH-90-40-G-AL-X-T01	*KH-90-40-G-SIC-X-T01
TYPE II (2x45°) / Ø59	✕	*KH-90-59-G-AL-X-T02	*KH-90-59-G-SIC-X-T02
TYPE III (2x45°) / Ø79	◆	*KH-90-79-G-AL-X-T03	*KH-90-79-G-SIC-X-T03
TYPE IV (2x30°) / Ø41	✕	*KH-60-41-G-AL-X-T04	*KH-60-41-G-SIC-X-T04
TYPE V (2x30°) / Ø60	✕	*KH-60-60-G-AL-X-T05	*KH-60-60-G-SIC-X-T05
TYPE VI (2x30°) / Ø80	◆	*KH-60-80-G-AL-X-T06	*KH-60-80-G-SIC-X-T06
TYPE VII (2x15°) / Ø40	✕	*KH-30-40-G-AL-X-T07	*KH-30-40-G-SIC-X-T07
TYPE IX (2x15°) / Ø59	◆	*KH-30-59-G-AL-X-T09	*KH-30-59-G-SIC-X-T09

✕ = VSA-05/1 ◆ = VSA-2/3

✕ = Minimum order quantity 10 pieces

◆ = Not available from stock





Ordering example:

Conical grinding sleeve TYP III 90° (2x45°) / Outer-Ø 79mm in silicon carbide (SiC) / grain P400

➔ **KH-90-79-G-SIC-400-T03**

21 GSS – grinding tool with metallic binding TYPE: GSS-

Standard grain: B252 (Other grains available on request)

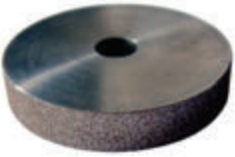
 <p>GSS-grinding spindles (SP1) for SL-15 / SL-2 / Valva-15 / SM</p>	Outer- Ø (mm)	1 Set (6 pieces) Type	
	30	GSS-SP1-030-B252-S	
	50	GSS-SP1-050-B252-S	
	80	GSS-SP1-080-B252-S	
	120	GSS-SP1-120-B252-S	
 <p>GSS-grinding spindles (SP2) for SL-3 / Valva-3</p>  <p>GSS-grinding spindles (SP3) for SLA / HSL / HSS</p>	Outer- Ø (mm)	1 Set (6 pieces) Type	
	80	GSS-SP2-080-B252-S	
	120	GSS-SP2-120-B252-S	
	40	GSS-SP3-040-B252-S	
	50	GSS-SP3-050-B252-S	
	60	GSS-SP3-060-B252-S	
	70	GSS-SP3-070-B252-S	
	80	GSS-SP3-080-B252-S	
	90	GSS-SP3-090-B252-S	
	100	GSS-SP3-100-B252-S	
	120	GSS-SP3-120-B252-S	
	 <p>GSS- grinding cup (ST) for VSA / TD / TDF / Grinding unit</p>	Outer- Ø (mm)	Type
		25 (mounting hole Ø10)	◆ GSS-ST-B10-025-B252
50 (mounting hole Ø10)		◆ GSS-ST-B10-050-B252	
60 (mounting hole Ø20)		◆ GSS-ST-B20-060-B252	
 <p>GSS- grinding wheel for bores (SRB) for VSA / TD / TDF / Grinding unit</p>	Outer- Ø (mm)	Type	
	55 (mounting hole Ø10)	◆ GSS-SRB-B10-055-B252	
	60 (mounting hole Ø20)	◆ GSS-SRB-B20-060-B252	

◆ = Not available from stock

 <p>GSS - grinding cone (SK) for VSA</p> <p>GSS – SK – Angle – Hole – Outer-Ø – Grain</p> <p>Available grain: B252 (coarse), B151 (medium) und B91 (fine)</p>	Angel Outer-Ø (mm)	Type
	30° (2x15°) Ø 40 (mounting hole Ø10)	◆ GSS-SK-30-B10-040-B252
		◆ GSS-SK-30-B10-040-B151
		◆ GSS-SK-30-B10-040-B91
	60° (2x30°) Ø 40 (mounting hole Ø10)	◆ GSS-SK-60-B10-040-B252
		◆ GSS-SK-60-B10-040-B151
		◆ GSS-SK-60-B10-040-B91
	90° (2x45°) Ø 40 (mounting hole Ø10)	◆ GSS-SK-90-B10-040-B252
		◆ GSS-SK-90-B10-040-B151
		◆ GSS-SK-90-B10-040-B91
	30° (2x15°) Ø 50 (mounting hole Ø20)	◆ GSS-SK-30-B20-050-B252
		◆ GSS-SK-30-B20-050-B151
◆ GSS-SK-30-B20-050-B91		
60° (2x30°) Ø 50 (mounting hole Ø20)	◆ GSS-SK-60-B20-050-B252	
	◆ GSS-SK-60-B20-050-B151	
	◆ GSS-SK-60-B20-050-B91	
90° (2x45°) Ø 50 (mounting hole Ø20)	◆ GSS-SK-90-B20-050-B252	
	◆ GSS-SK-90-B20-050-B151	
	◆ GSS-SK-90-B20-050-B91	

◆ = Not available from stock

 <p>Special-GSS- grinding cone (SK) only for EFCO-HSS</p>	Type
	◆ GSS – SK – Angle – Outer-Ø – B252 Design of customer's specification

◆ = Not available from stock

22 Cup grinding wheel for VSA-machines **TYPE: ST-**



- Available in special fused aluminium oxide (**AL**) Al_2O_3 or silicon carbide (**SIC**) SiC
- Grain (**X**): P60, P120

Outer-Ø (mm)	Type	
25 (mounting hole Ø10)	ST-B10-025-AL-X	ST-B10-025-SIC-X
41 (mounting hole Ø10)	ST-B10-041-AL-X	ST-B10-041-SIC-X
60 (mounting hole Ø20)	ST-B20-060-AL-X	ST-B20-060-SIC-X

Ordering example:

Cup grinding wheel with mounting hole Ø 10mm und outer-Ø 41mm in silicon carbide (SIC) / grain P120

➔ **ST-B10-041-SIC-120**