

**BUILDING PERFORMANCE
SERVICES**

**AUTOMATION
& OPTIMIZATION**

**HEATING
& COOLING**

**PLUMBING &
WATER SUPPLY**

FIRE SAFETY

**REPLACEMENT
PARTS**

Your guide to the
complete line of
Armstrong products
and services



S.A. ARMSTRONG
LIMITED

23

1971] Armstrong develops the world's first Vertical In-Line centrifugal pumps for HVAC markets

1994] DualArm: the first truly integrated parallel multi-head pump is introduced

2005] Introduction of Intelligent Variable Speed (IVS) pumps

2007] Introduction of Design Envelope technology to commercial pumps, and subsequently, other product lines

2014] Parallel Sensorless introduced, boosting parallel pumping efficiencies to unprecedented levels

2017] Introduction of Cloud-based performance management services, allowing for proactive and informed decisions for best possible HVAC performance.

A LEGACY OF INNOVATION

ESTABLISHED
1934

Armstrong Fluid Technology produces the most innovative and energy-efficient fluid flow and control equipment for HVAC and water-based process application. Throughout its 80 year history, Armstrong has introduced groundbreaking innovations that elevated industry practice and substantially improved the quality and performance of pumping and HVAC installations.

The process of continuous innovation has led to Design Envelope technology — the integration of advanced mechanical capabilities and controls intelligence. Design Envelope technology is central to our highest-efficiency, lowest cost pumping and HVAC solutions.

EFFICIENT AND EFFECTIVE SOLUTIONS, THE WORLD OVER.

Since 1934, Armstrong Fluid Technology has grown into a leading supplier of superior pumping and HVAC equipment. With over 1000 employees worldwide, operating seven manufacturing facilities on three continents, Armstrong is known today as a guarantor of design quality, long service life, and exceptional operating economy.



5 DESIGN ENVELOPE TECHNOLOGY

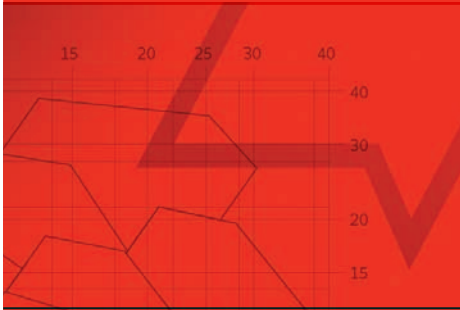

Armstrong's innovative Design Envelope technology combines highest operating efficiency with lowest installed cost **and** lowest operating cost for your HVAC or water process applications. Design Envelope technology helps lower your project risks and meet your sustainability goals - surpassing ASHRAE 90.1 requirements at an industry-best three-year warranty.

7 BUILDING SERVICES & DESIGN

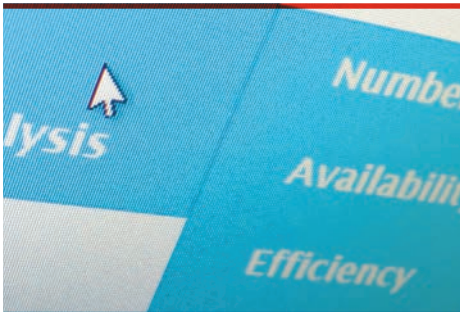

We offer a range of expert services to assist you in achieving the building performance you require. Services range from evaluating current operational equipment and energy efficiencies to delivering complete ultra-efficient chilled water plants.

9 HEATING & COOLING



From individual equipment to complete ultra-efficient chilled water plants, our expertise in demand based control, fluid flow, variable speed, and heat transfer gives you the industry-leading outcomes you expect.

22 PLUMBING & WATER SUPPLY



We furnish your building with the most efficient and safest booster and water supply equipment featuring cutting-edge capabilities such as soft fill, no-flow shutdown, and sensorless pressure optimization. All equipment complies with ASHRAE 90.1, SDWA 1417 (Safe Drinking Water Act), and NSF ANSI 372 & 61.

31 FIRE SAFETY



Our proven and reliable fire safety pumps, controls, and packages meet the most demanding test standards and applications. Armstrong fire safety equipment is available in diesel as well as electrically-driven versions.

32 REPLACEMENT PARTS



Genuine factory parts keep your Armstrong equipment and systems operating reliably with a long service life - for the way they were originally designed. Our upgraded maintenance-free bearing assemblies also work as replacement parts for other makes.

DESIGN ENVELOPE



Design Envelope technology replaces mechanical components with electronics and software intelligence in order to:

Boost energy efficiency

Downsize equipment

Optimize part-load performance

As a design or building professional, this helps you achieve the lowest installed cost, lowest operating cost, and lowest environmental impact with your mechanical designs and installations. Design Envelope technology puts your projects at the sustainability forefront, in energy savings, cost savings, and carbon savings.

ENERGY SAVINGS

Savings for our clients' Design Envelope installations worldwide since 2007.

357,152

Tonnes of CO₂ equivalent*

1,085,505,948

kWh electricity*

*as of February, 2018

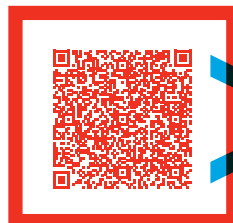

Scan to discover more benefits of Design Envelope technology for your new or retrofit project.



HIGHEST
ENERGY EFFICIENCY



LOWEST
INSTALLED
COST



LOWEST
OPERATING COST



LOWEST
ENVIRONMENTAL COST



LOWEST
PROJECT
& OPERATING RISK

FLAGSHIP EFFICIENCY

A COMMERCIAL
FACILITY
CASE STUDY



RBC Tower

A flexible HVAC system includes responsive HVAC controls that provide individual cooling at high efficiencies. The application draws on Toronto's Enwave deep lake water cooling system to dramatically reduce energy and operating cost.

The RBC
Centre has
achieved a

50%
ENERGY
SAVINGS

relative to
similar towers
built to
standard code.



Scan to learn
more about this
case study.



We offer a range of expert services to assist you in achieving the building performance you require. Services range from evaluating current operational equipment and system energy efficiency to delivering complete ultra-efficient chilled water plants.

The Armstrong Energy Audit quantifies current baseline operating parameters and system efficiency

Identifies opportunities for energy optimization

Enables the industry-best Armstrong Savings Guarantee

ENERGY AUDIT



The Armstrong Design Assist is an expert planning and design service that optimizes chilled water plant designs

Improves plant layouts for most economic component and material usage

Meets the latest building load and code compliance requirements

DESIGN ASSIST

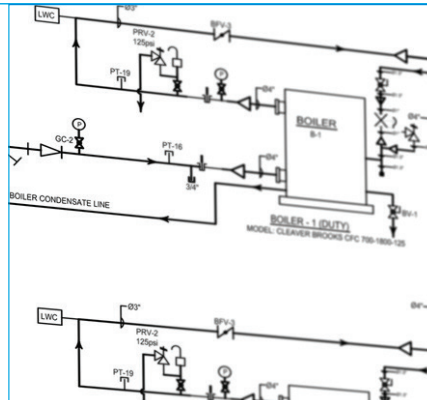

The Armstrong Project Assist service provides professional project management, ensuring Armstrong equipment is scheduled, delivered and installed to the highest possible standards. Project Assist is included as a complementary service with most Armstrong HVAC packages, control systems and energy optimization projects.

PROJECT ASSIST

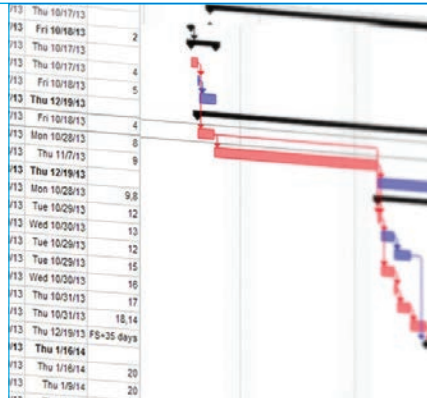

DESIGN ENVELOPE APPLICATION GUIDES

Experience the value of Design Envelope technology and get assistance with its application with a growing set of Design Envelope application guides.

Each application guide covers a standard HVAC design scenario commonly found in certain building types, use, and location. Application guides discuss significant improvements — technically, financially, and environmentally — resulting from choosing Design Envelope technology over a more traditional approach.

See currently available app guides on our website



The Armstrong Start-up Assist service ensures that sophisticated HVAC equipment is started and commissioned properly. Installations are being expertly calibrated to their respective site conditions, leaving them operationally prepared to deliver optimum lifetime performance.

START UP ASSIST



ECO*Pulse HVAC Health Management is a subscription-based HVAC service for improving and maintaining chilled water plant energy efficiency. ECO*Pulse gives you invaluable insights and alerts to help diagnose problems before they become acute.

ECO*PULSE™ HVAC HEALTH MANAGEMENT

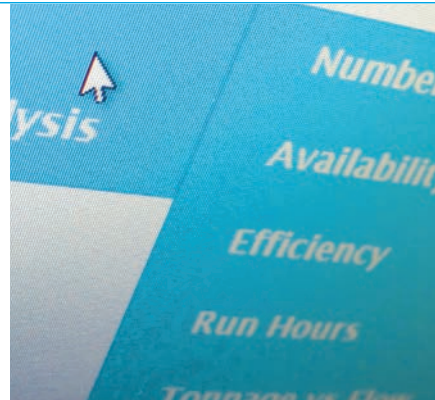

24/7 remote monitoring

An operational dashboard

Email notification of parameter exceedance

TOWERMAX is an optimization service for IPC 9521 variable speed chiller plants that boosts energy and water savings, available as an upgrade for any previous installation.

TOWERMAX UPGRADE BUNDLE



Optimization sequences save energy and water

Up to 25% energy savings

Includes ECO*PULSE subscription

CONTROLS & AUTOMATION

Ultimate system performance requires seamless integration of mechanical equipment, sensing and controls with solid technical and logistics support. Armstrong HVAC control systems enable you to meet operating budgets, project schedules and environmental goals with a single point of supplier accountability.

WATER COOLED CHILLER PLANT CONTROL SYSTEMS

- Boosts energy efficiencies of new and existing chiller plant installations to class-leading levels
- Controls up to five chillers and five pumps
- Integrates with all brands of chillers, pumps, and building automation systems

DESIGN ENVELOPE 9521 INTEGRATED PLANT CONTROL SYSTEM



AIR COOLED CHILLER PLANT CONTROL SYSTEMS

- Boosts energy efficiencies of new and existing chiller plant installations to class-leading levels
- Controls up to five chillers and five pumps
- Integrates with all brands of chillers, pumps, and automation systems

DESIGN ENVELOPE 9511 INTEGRATED PLANT CONTROL SYSTEM



- Doubles the average annual energy efficiency of current systems in conjunction with all-variable speed plants (variable speed chillers, cooling towers, condenser and distribution pumps)
- Controls up to six chillers per plant

DESIGN ENVELOPE 11550 & 11000 INTEGRATED PLANT CONTROL SYSTEM



- Reduces energy rates
- Simplified tower automation and easy integration for improved system reliability
- Real-time flow metering accuracy and diagnostics to better understand your tower performance

DESIGN ENVELOPE ITC 9521 INTEGRATED TOWER CONTROL SYSTEM



INTEGRATED TOWER CONTROL SYSTEM

- Interfaces seamlessly with any existing building automation to maximize overall plant efficiency - without replacing or reconfiguring existing componentry
- Integrates with all brands of chillers, pumps, and building automation systems

OPTI-VISOR™



- Advanced multi-zone control that directly integrates with pumping units to optimize energy performance, system handling, and installation
- Controls up to 6 pumps and 12 zones
- No limitations in system size and capacity

DESIGN ENVELOPE 4000 INTEGRATED PUMPING SYSTEM



PUMPING CONTROL SYSTEMS

PACKAGED SYSTEMS

- A**rmstrong packaged systems deliver a variety of benefits to your project including:
- Reduced risk to project schedule
 - Reduced risk of scope omissions and cost impacts
 - Conformance to construction schedule
 - Single point of supplier accountability
 - Expert design for optimal performance

FLUID MANAGEMENT PACKAGES

- Integrates pump and control technology into a single pumping solution yielding
 - + compact footprint
 - + energy efficiency
 - + rapid installation
- Up to 4 pumps in 1 unit
- Catalogue-based pre-engineered solutions or custom-designed to specification

**DESIGN ENVELOPE
INTELLIGENT FLUID
MANAGEMENT SYSTEM**

**DESIGN
ENVELOPE**



BOILER & CHILLER PLANT PACKAGES

- The factory-assembled plant includes pumps, integrated controls, water-cooled chillers and the requisite instrumentation, valves and sensors
- IPP complies with all ASHRAE 189.1 requirements and exceeds ASHRAE 90.1

**DESIGN ENVELOPE
CHILLED-WATER
INTEGRATED PLANT
PACKAGE**

**DESIGN
ENVELOPE**

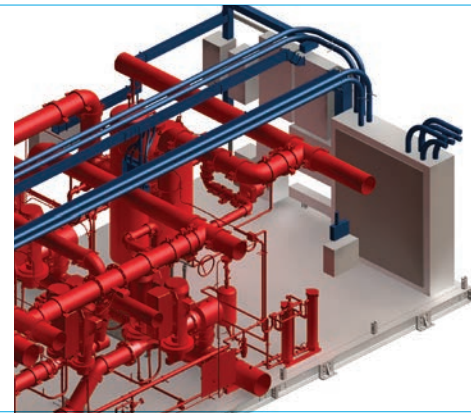

- Includes a combination of: structural, process equipment, controls, electrical gear, and environmental enclosures that are designed and fabricated to customer specifications
- For indoor or outdoor applications in environments ranging from -40°F up to +120°F

**ENGINEERED-TO-
ORDER PACKAGED
HVAC SYSTEMS**

**DESIGN
ENVELOPE**



COMMERCIAL PUMPS

Armstrong pumps have been synonymous with superior design, reliability, maintainability, and operating efficiency. Our Design Envelope pumps deliver the lowest installed and lowest operating costs with the industry-leading warranty - resulting in the best ROI and shortest payback periods compared to any other pumping equipment available in the market today.

VERTICAL IN-LINE | SPLIT-COUPLED

- Pipe-mounted two-pump unit with integrated intelligent controls for space-saving installation
- Up to 900 USgpm flow; up to 160 ft head
- Temperature: 300°F
- Power: 1 hp to 10 hp
- Size: 1½" to 3"

DESIGN ENVELOPE
4322 TANGO PUMPS

DESIGN
ENVELOPE



VERTICAL IN-LINE | CLOSE-COUPLED

- Pipe-mounted two-pump unit with integrated intelligent controls and duty/standby operation.
- Up to 900 USgpm flow; up to 160 ft head
- Temperature: 250°F
- Power: 1 hp to 10 hp
- Size: 1½" to 3"

DESIGN ENVELOPE
4372 TANGO PUMPS

DESIGN
ENVELOPE



- Pipe-mounted two-pump unit with integrated intelligent controls and duty/standby or parallel-pumping operation
- Up to 1250 USgpm flow; up to 250 ft head
- Temperature: 250°F
- Power: 1 hp to 75 hp
- Size: 3" to 8"

DESIGN ENVELOPE
4302 DUALARM PUMPS

DESIGN
ENVELOPE



- Pipe-mounted two-pump unit with integrated intelligent controls and duty/standby or parallel-pumping operation
- Up to 1000 USgpm flow; up to 140 ft head
- Temperature: 250°F
- Power: 1 hp to 7½ hp
- Size: 3" to 8"

DESIGN ENVELOPE
4382 DUALARM PUMPS

DESIGN
ENVELOPE



- Pipe-mounted UL 778 pumping unit with integrated intelligent controls for space-saving installation and superior energy performance
- 25 to 25,000 USgpm flow; 10 to 300 ft head
- Temperature: 300°F
- Power: 1 hp to 1250 hp
- Size: 1½" to 20"

DESIGN ENVELOPE
4300 PUMPS

DESIGN
ENVELOPE



- Pipe-mounted pump unit with integrated intelligent controls for space-saving installation and superior energy performance
- Up to 1000 USgpm flow; up to 140 ft head
- Temperature: 250°F
- Power: 1 hp to 10 hp
- Size: 1½" to 6"

DESIGN ENVELOPE
4380 PUMPS

DESIGN
ENVELOPE



COMMERCIAL PUMPS

HORIZONTAL

- Base mounted end-suction horizontal pumping unit with integrated intelligent controls for easier installation
- 25 to 4500 USgpm flow; 10 to 400 ft head
- Power: 1 hp to 125 hp
- Temperature: 300°F
- Size: 1.5" to 8"

DESIGN ENVELOPE
4200H

DESIGN
ENVELOPE



HORIZONTAL

- Motor-mounted pump unit with integrated intelligent controls for space-saving installation
- Up to 1000 USgpm flow; up to 125 ft head
- Power: 1 hp to 7.5 hp
- Temperature: 250°F
- Size: 1.5" to 6"

DESIGN ENVELOPE
4280

DESIGN
ENVELOPE



STORING FOOD MOVING HEAT

A RETAIL FACILITY CASE STUDY

Sainsbury's

Optimum flow and pressure required at any given moment reduces energy usage by as much as

70%

compared to fixed speed alternatives.

Sainsbury's and Greenfield selected Armstrong Design Envelope pumps for performance, pumping efficiency and intelligent variable speed technology.



Scan to learn more about this case study

COMMERCIAL PUMPS

VERTICAL IN-LINE | SPLIT-COUPLED

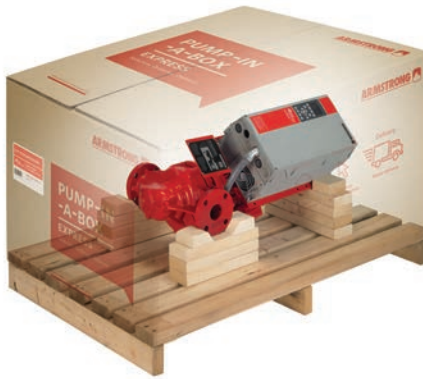
DESIGN
ENVELOPE

- Pipe-mounted pump unit with integrated intelligent controls for space-saving installation and superior energy performance. Available for express shipment, usually within 48 hours
- Up to 550 USgpm flow; up to 130 ft head
- 10 hp to 15 hp

DESIGN ENVELOPE
4300 PUMP-IN-A-BOX

VERTICAL IN-LINE | CLOSE-COUPLED

DESIGN
ENVELOPE

- Pipe-mounted pump unit with integrated intelligent controls for space-saving installation and superior energy performance. Available for express shipment, usually within 48 hours
- Up to 400 USgpm flow; up to 100 ft head
- Power: 1 hp to 7½ hp

DESIGN ENVELOPE
4380 PUMP-IN-A-BOX

- The Armstrong 4302 DualArm pumps are pipe-mounted two-pump units designed for space-saving installation and duty/standby or parallel pumping operation
- Up to 1250 USgpm flow; up to 450 ft head
- Power: 1 hp to 150 hp
- Size: 3" to 8"

4302 VERTICAL
IN-LINE
DUALARM PUMPS



- The Armstrong 4382 DualArm pumps are pipe-mounted two-pump units designed for space-saving installation and duty/standby or parallel pumping operation
- Up to 1250 USgpm flow; up to 400 ft head
- Power: .33 hp to 60 hp
- Size: 3" to 8"

4382 VERTICAL IN-LINE
DUALARM PUMPS



- The Armstrong 4300 pipe-mounted pumps are designed for space-saving installation, high operating efficiency, and long service life
- Up to 28000 USgpm flow; up to 500 ft head
- Temperature: 300°F
- Power: 1 hp to 1250 hp
- Size: 1½" to 20"

4300 VERTICAL
IN-LINE PUMPS



- The Armstrong 4380 pipe-mounted pumps are designed for space-saving installation and long service life
- Up to 2500 USgpm flow; up to 300 ft head
- Temperature: 250°F
- Power: 0.33 hp to 60 hp
- Size: 1½" to 8"

4380 VERTICAL
IN-LINE PUMPS



COMMERCIAL PUMPS

VERTICAL IN-LINE | SPLIT-COUPLED

- Pipe-mounted 2-pump units designed for space-saving installation and duty/standby operation
- Up to 1250 USgpm flow; up to 400 ft head
- Power: 1 hp to 100 hp
- Temperature: 121°F
- Size: 2" to 6"



4312 VERTICAL IN-LINE TWIN PUMPS

VERTICAL IN-LINE | CLOSE-COUPLED

- Pipe-mounted 2-pump units designed for space-saving installation and duty/standby operation
- Up to 1250 USgpm flow; up to 350 ft head
- Power: 0.33 hp to 60 hp
- Temperature: 250°F
- Size: 2" to 5"



4392 VERTICAL IN-LINE TWIN PUMPS

COOLING SYSTEM TRANSPLANT

A HEALTH CARE FACILITY CASE STUDY

Methodist Dallas Medical Center

After a retrofit installation of updated HVAC equipment, Methodist Dallas Medical Center reduced cooling costs by

\$107,000

IN JUST FIVE MONTHS

Armstrong chilled water and condenser water pumps, controlled by an Integrated Plant Controller (IPC)11550 in addition to a new chiller and cooling tower converted this cooling

installation to an all variable speed system.



Scan to learn more about this case study

COMMERCIAL PUMPS

VERTICAL IN-LINE | CLOSE-COUPLED

- The Armstrong 4360 pipe-mounted pumps are designed for space-saving installation and long service life
- Up to 350 USgpm flow; up to 200 ft head
- Temperature: 225°F
- Power: 0.33 hp to 15 hp
- Size: 1¼" to 3"

4360 VERTICAL
IN-LINE PUMPS

HORIZONTAL

- Reduces cost across installation, operation, and lifetime maintenance. High-efficiency NEMA-premium motors ensure low energy consumption and cost
- Up to 5000 USgpm flow; up to 600 ft head
- Temperature: 250°F
- Power: 0.33 hp to 300 hp

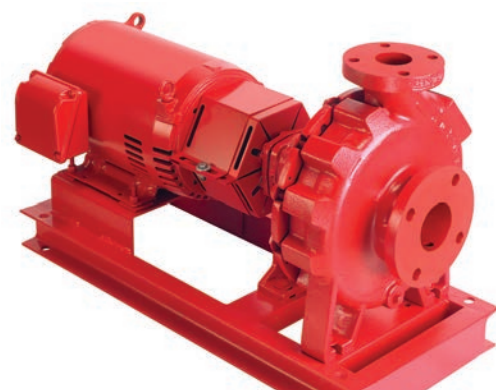
4030 END
SUCTION BASE
MOUNTED PUMPS

- Pipe-mounted pumps designed for space-saving installation; available for express shipment, typically within 48 hours
- Up to 175 USgpm flow; up to 90 ft head
- Temperature: 225°F
- Power: 0½ hp to 3 hp
- Size: 1¼" to 3"

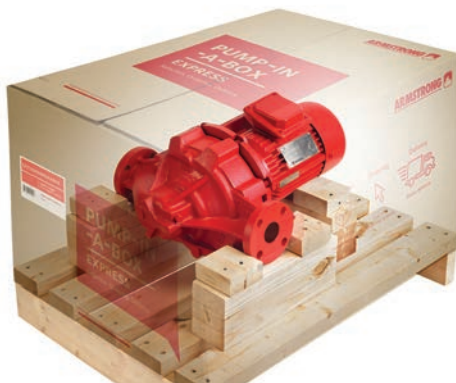
4360
PUMP-IN-A-BOX

- End-suction pumps equipped with close-coupled motors to minimize footprint requirements
- Up to 2000 USgpm flow; up to 400 ft head
- Temperature: 250°F
- Power: 0.33 hp to 60 hp
- Size: 1" to 6"

4280 MOTOR MOUNT-
ED PUMPS

- Pipe-mounted pumps designed for space-saving installation and long service life; available for express shipment, typically within 48 hours
- Up to 450 USgpm flow; up to 90 ft head
- Temperature: 250°F
- Power: 1 hp to 7½ hp
- Size: 1½" to 4"

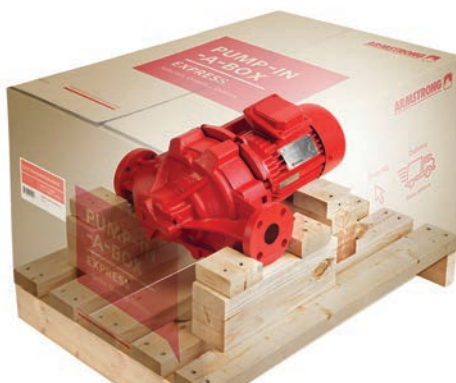
4380
PUMP-IN-A-BOX

- Close coupled horizontal pumps, motor mounted and designed for long service life and easy maintenance
- Up to 3600 USgpm flow; up to 130 ft head
- Temperature: 275°F
- Power: 0.33 hp to 60 hp
- Size: 1¼", 1½", 2"

4270 & 4270 STOCK
MOTOR MOUNTED
PUMPS

COMMERCIAL PUMPS

VERTICAL IN-LINE | SPLIT-COUPLED

- Designed for reliability and low maintenance cost
- Up to 400 USgpm flow; up to 900 ft head
- Temperature: 250°F
- Power: 0½ hp to 50 hp
- Size: 1¼" to 4"

4700 VERTICAL MULTI-STAGE PUMPS



HORIZONTAL

- Engineered to reduce cost across installation, operation, and lifetime maintenance. High-efficiency NEMA-premium motors ensure low energy consumption and cost
- Up to 7000 USgpm flow; up to 600 ft head
- Temperature: 225°F
- Power: 1½ hp to 500 hp

4600 HORIZONTAL SPLIT-CASE PUMPS



LIVING UP TO LEED

A HIGH RISE
RESIDENTIAL
FACILITY CASE STUDY

Ventus at Metrogate

The Armstrong installation controlled by a Parallel Sensorless Pump Controller proved to be

**32%
MORE
EFFICIENT**

than the industry-leading BMS solution.

Armstrong Parallel Sensorless technology enables best efficiency staging of two Design Envelope pumps in a parallel configuration, achieving previously unheard-of energy efficiency levels. Tridel upgraded the HVAC system to reduce energy costs and compare two competing control solutions.



Scan to learn more about this case study

LIGHT COMMERCIAL & RESIDENTIAL PUMPS

The Armstrong Design Envelope Compass circulator embeds the latest motor and control technologies, providing you with the ultimate in flexibility, operating comfort, and energy efficiency. Our broad offering of wet-rotor and dry-rotor designs help you respond to any hydronic situation with ease and confidence.

WET ROTOR DESIGN

- Designed to replace existing fixed speed circulators, with popular flange-to-flange dimensions. A universal replacement for all circulators in its capacity range
- Cast iron and stainless steel volutes
- Up to 20 USgpm flow; up to 20 ft head
- Power: 5W to 45W

DESIGN ENVELOPE
COMPASS H CIRCULATORDESIGN
ENVELOPE

DRY ROTOR DESIGN

- Draws on advanced motor technology and efficient hydraulic design to achieve excellent wire-to-water duty point efficiencies
- Up to 140 USgpm flow; up to 60 ft head
- Temperature: 110°F
- Power: ¼ hp to ¾ hp
- Size: ¾" to 3"

E.2 CIRCULATORS



- Circulates water or ethylene-glycol solutions in closed hydronic or solar heating systems. Available in three volute materials for residential, small industrial, and commercial applications
- Up to 64 USgpm flow; up to 42 ft head
- Power: 33W to 218W

ASTRO 2
CIRCULATORS

- For commercial systems that require higher flow and pressure. Offers the flexibility of customizing the flow curve to specific application requirements
- Up to 250 USgpm flow; up to 55 ft head
- Temperature: 107°F
- Power: ¼ hp to 3 hp
- Size: ¾" to 3"

1050/1060, 3-PIECE
CIRCULATORS

DRY ROTOR DESIGN

- Designed to replace existing fixed speed circulators, with popular flange-to-flange dimensions. A universal replacement for all circulators in its capacity range
- Cast iron and stainless steel volutes
- Up to 75 USgpm flow; up to 20 ft head
- Power: ¾ hp

DESIGN ENVELOPE
COMPASS R CIRCULATORDESIGN
ENVELOPE

- For commercial systems that require higher flow and pressure. Offers the flexibility of customizing the flow curve to specific application requirements
- Up to 250 USgpm flow; up to 55 ft head
- Temperature: 107°F
- Power: ¼ hp to 3 hp
- Size: ¾" to 2"

S&H 3-PIECE
CIRCULATORS

LIGHT COMMERCIAL & RESIDENTIAL PUMPS

DRY ROTOR DESIGN

- A complete repair solution for the s&H circulator line. Armstrong PLVs can also be used to rebuild or upgrade select ITT/ B&G circulator models
- Up to 120 USgpm flow; up to 60 ft head
- Temperature: 29°F
- Power: 1/12 hp to 2 hp

**S&H CIRCULATOR
LESS VOLUTE**

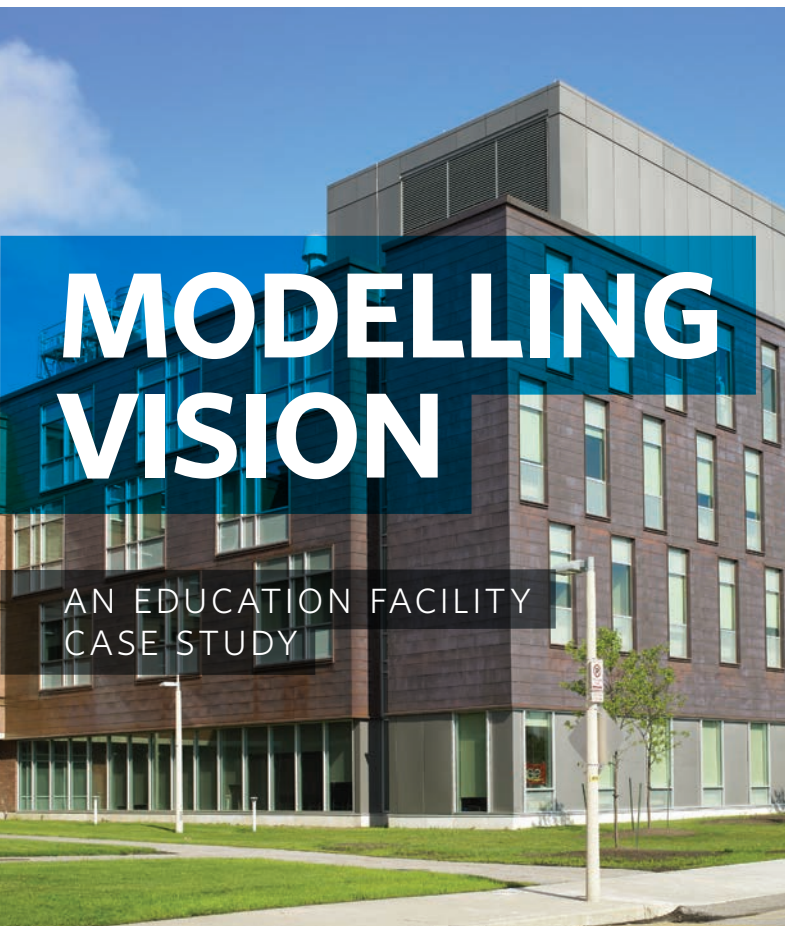

MODELLING VISION

AN EDUCATION FACILITY
CASE STUDY

The University of Ontario Institute of Technology

Design Envelope solutions, integrated with custom-designed geothermal systems, deliver energy efficiency that is

**50%
BETTER**

than the industry-leading BMS solution.

Designers created an innovative geothermal heating and cooling system linking each building to a central HVAC plant. Asked about the success of the installation, Mutal Mechanical commented: “Managers and maintenance staff from uoit are delighted with the performance and reliability of the Armstrong equipment.”



Scan to learn more about this case study

HEAT EXCHANGERS

High quality and durability combined with excellent heat transfer rates have placed Armstrong heat exchangers and tank heaters amongst the top in their categories. In concert with other Armstrong equipment, Armstrong heat exchangers are a critical component for getting the maximum performance from your HVAC and fluid flow system.

- Suitable for use in any installation involving hot water boilers. The wide range of in stock models assures fast project turnaround
- In-stock selection covers applications from 0.5 USgpm to 160 USgpm. Larger models available for up to 600 USgpm



**ABX BRAZED PLATE
HEAT EXCHANGERS**

- Provides dependable, efficient heat transfer in various applications ranging from HVAC to industrial installations. Armstrong Shell & Tube heat exchangers are suitable for higher-pressure applications in oil refineries and other large chemical processes



**SHELL & TUBE HEAT
EXCHANGERS**

- Optimized for best water-to-water heat transfer providing enhanced performance especially in HVAC applications
- Performance range: 150 psi standard pressure rating. Pressure rating up to 435 psi available.



**PLATE AND FRAME
HEAT EXCHANGERS**

- Internal tube bundles designed for use with agitated or non-agitated tanks
- 150 psi standard pressure rating
- Temperature: 35°F to 375°F
- Size: 4" to 20"

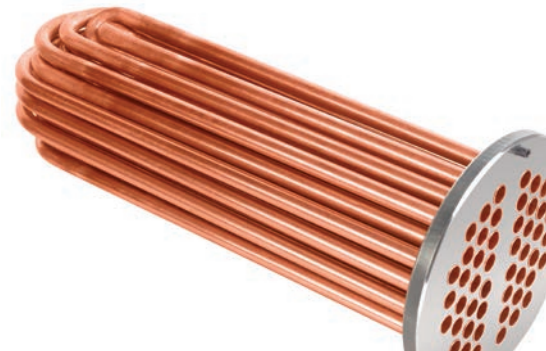

TANK HEATERS

ACCESSORIES

To make sure you get the best possible results from your mechanical room designs and installations we carry an assortment of high-quality ancillary products. By using Armstrong accessories you can be certain no quality low points and operating bottlenecks get in the way of your system performance.

- Multi-function pump fittings that provide a 90° elbow, guide vanes, and an in-line strainer. Suction guides reduce pump installation cost and floor space requirements
- Suitable for all Armstrong commercial pumps and pumping systems
- Size: 1½" to 20"

SUCTION GUIDES

DESIGN
ENVELOPE

- Designed to eliminate trapped air and suspended dirt particles associated with the start-up and maintenance of hydronic and HVAC systems

DIRT & AIR
SEPARATORS

- Multi-function pump fittings that reduce equipment and installation costs
- Suitable for all Armstrong commercial pumps
- Size: 1½" to 20"

FLO-TREX VALVES

DESIGN
ENVELOPE

- Provide automatic glycol make-up for HVAC systems. The specially molded mixing tank offers a compact package with built-in housing for controls and make-up pump
- Suitable for all bladder and compression tanks up to 90 psi (621 kPa) cold-fill pressure

GLYCOL
AUTOFILL UNITS

- Designed to reduce tank sizes by up to 80% over standard designs
- Range: AET plain steel expansion tanks: 15 to 525 USgpm flow; AX diaphragm expansion tanks: 8 to 211 USgpm flow; Type L bladder type expansion tanks: 10 to 1056 USgpm flow

EXPANSION TANKS



ACCESSORIES

- ½" to 2" models feature multi-turn adjustment for precise control, hidden memory stops to set balance point and soft seats for positive shutoff
- Temperature: -4°F to 300°F
- Size: ½" to 2"

CIRCUIT BALANCING VALVES (½"-2")

- Intelligent Variable Speed controller to upgrade new and existing constant speed or variable-frequency operated pumps
- Power: 1 hp to 1250 hp motor control
- Temperature: 115°F daily average

IVS 102 INTELLIGENT VARIABLE SPEED CONTROLLER

- 2½" to 12" models feature multi-turn adjustment for precise control, hidden memory stops to set balance point and soft seats for positive shutoff
- Temperature: 230°F
- Size: 2½" to 12"

CIRCUIT BALANCING VALVES (2"-12")

- Built with high-quality materials for premium energy-efficiency and long service life
- Temperature: Designed for class B temperature rise and equipped with superior class F insulation. Maximum ambient temp 40°C (unless approved differently)
- Power: 0.33 hp to 1250 hp

MOTORS

WATER BOOSTERS

With Armstrong boosters you choose high-quality design, 24/7 availability, and long service life. Our Design Envelope boosters provide you with superior energy efficiency, resulting in the lowest operating cost and environmental impact. All Armstrong boosters are available in lead-free versions, fulfilling today's most stringent drinking water handling standards.

- Fully assembled, programmed, integrated and factory-tested turn-key booster systems. Equipped with vertical multistage pumps; arrangements of two to five pumps
- Up to 2000 USgpm flow; up to 370 psi
- Power: Up to 250 hp



DESIGN ENVELOPE
6800 VERTICAL
MULTISTAGE BOOSTERS

- Fully assembled, programmed, integrated and factory-tested turn-key booster systems. Equipped with vertical multistage pumps; arrangements of two to five pumps
- Power: Up to 7½ hp (close coupled pumps), up to 20 hp (split coupled pumps)



DESIGN ENVELOPE
6900 DUALPAK
BOOSTERS



RESCHEDULED
FLIGHT PLANS

A TRANSPORTATION
FACILITY CASE STUDY

Edmonton International Airport
Expansion project

The engineers on the project estimate that they saved approximately

\$12,000

IN DESIGN
RELATED
TIME

The Edmonton Regional Airport Authority chose Armstrong VIL pumps for their expansion project. The choice of Design Envelope technology was

prescient, as the pumps were able to serve the installation despite substantial changes in HVAC load.



Scan to learn more about this case study

COMMERCIAL PUMPS

Armstrong pumps have been synonymous with superior design, reliability, maintainability, and operating efficiency. Our Design Envelope pumps deliver the lowest installed and lowest operating costs with the industry-best warranty - resulting in the best ROI and shortest payback periods compared to any other pumping equipment available in the market today.

VERTICAL IN-LINE | SPLIT-COUPLED

- Pipe-mounted two-pump unit with integrated intelligent controls for space-saving installation
- Up to 900 USgpm flow; up to 160 ft head
- Temperature: 300°F
- Power: 1 hp to 10 hp
- Size: 1½" to 3"

DESIGN ENVELOPE



DESIGN ENVELOPE
4322 TANGO PUMPS

VERTICAL IN-LINE | CLOSE-COUPLED

- Pipe-mounted two-pump unit with integrated intelligent controls and duty/standby operation.
- Up to 900 USgpm flow; up to 160 ft head
- Temperature: 250°F
- Power: 1 hp to 10 hp
- Size: 1½" to 3"

DESIGN ENVELOPE



DESIGN ENVELOPE
4372 TANGO PUMPS

- Pipe-mounted two-pump unit with integrated intelligent controls and duty/standby or parallel-pumping operation
- Up to 1250 USgpm flow; up to 250 ft head
- Temperature: 250°F
- Power: 1 hp to 75 hp
- Size: 3" to 8"

DESIGN ENVELOPE



DESIGN ENVELOPE
4302 DUALARM PUMPS

- Pipe-mounted two-pump unit with integrated intelligent controls and duty/standby or parallel-pumping operation
- Up to 1000 USgpm flow; up to 140 ft head
- Temperature: 250°F
- Power: 1 hp to 7½ hp
- Size: 3" to 8"

DESIGN ENVELOPE



DESIGN ENVELOPE
4382 DUALARM PUMPS

- Pipe-mounted UL 778 pumping unit with integrated intelligent controls for space-saving installation and superior energy performance
- 25 to 25,000 USgpm flow; 10 to 300 ft head
- Temperature: 300°F
- Power: 1 hp to 1250 hp
- Size: 1½" to 20"

DESIGN ENVELOPE



DESIGN ENVELOPE
4300 PUMPS

- Pipe-mounted pump unit with integrated intelligent controls for space-saving installation and superior energy performance
- Up to 1000 USgpm flow; up to 140 ft head
- Temperature: 250°F
- Power: 1 hp to 10 hp
- Size: 1½" to 6"

DESIGN ENVELOPE



DESIGN ENVELOPE
4380 PUMPS

VERTICAL IN-LINE | SPLIT-COUPLED

DESIGN ENVELOPE



- Pipe-mounted pump unit with integrated intelligent controls for space-saving installation and superior energy performance. Available for express shipment, usually within 48 hours
- Up to 550 USgpm flow; up to 130 ft head
- 10 hp to 15 hp

DESIGN ENVELOPE
4300 PUMP-IN-A-BOX

VERTICAL IN-LINE | CLOSE-COUPLED

DESIGN ENVELOPE

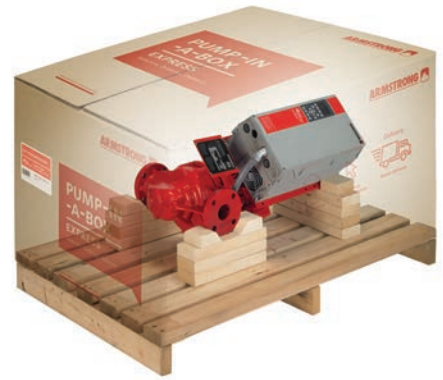

- Pipe-mounted pump unit with integrated intelligent controls for space-saving installation and superior energy performance. Available for express shipment, usually within 48 hours
- Up to 400 USgpm flow; up to 100 ft head
- Power: 1 hp to 7½ hp

DESIGN ENVELOPE
4380 PUMP-IN-A-BOX

- The Armstrong 4300 pipe-mounted pumps are designed for space-saving installation, high operating efficiency, and long service life
- Up to 28000 USgpm flow; up to 500 ft head
- Temperature: 300°F
- Power: 1 hp to 1250 hp
- Size: 1½" to 20"

4300 VERTICAL
IN-LINE PUMPS



- The Armstrong 4380 pipe-mounted pumps are designed for space-saving installation and long service life
- Up to 2500 USgpm flow; up to 300 ft head
- Temperature: 250°F
- Power: 0.33 hp to 60 hp
- Size: 1½" to 8"

4380 VERTICAL
IN-LINE PUMPS



- The Armstrong 4302 DualArm pumps are pipe-mounted two-pump units designed for space-saving installation and duty/standby or parallel pumping operation
- Up to 1250 USgpm flow; up to 450 ft head
- Power: 1 hp to 150 hp
- Size: 3" to 8"

4302 VERTICAL
IN-LINE
DUALARM PUMPS



- The Armstrong 4382 DualArm pumps are pipe-mounted two-pump units designed for space-saving installation and duty/standby or parallel pumping operation
- Up to 1250 USgpm flow; up to 400 ft head
- Power: .33 hp to 60 hp
- Size: 3" to 8"

4382 VERTICAL IN-LINE
DUALARM PUMPS



COMMERCIAL PUMPS

VERTICAL IN-LINE | SPLIT-COUPLED



- Pipe-mounted 2-pump units designed for space-saving installation and duty/standby operation
- Up to 1250 USgpm flow; up to 400 ft head
- Power: 1 hp to 100 hp
- Temperature: 121°F
- Size: 2" to 6"

4312 VERTICAL IN-LINE TWIN PUMPS

VERTICAL IN-LINE | CLOSE-COUPLED



- Pipe-mounted 2-pump units designed for space-saving installation and duty/standby operation
- Up to 1250 USgpm flow; up to 350 ft head
- Power: 0.33 hp to 60 hp
- Temperature: 250°F
- Size: 2" to 5"

4392 VERTICAL IN-LINE TWIN PUMPS



SAVINGS DELIVERED BETWEEN TRAINS

A TRANSPORTATION FACILITY CASE STUDY

Anacostia Station

The WMATA installed a variable speed, packaged pumping solution that has reduced their energy costs by over

\$8,500

PER YEAR

The Armstrong Design Envelope iFMS is a factory assembled, packaged pumping system that uses advanced variable speed technology to adjust pumping speed in response to HVAC system demand.



Scan to learn more about this case study

COMMERCIAL PUMPS

VERTICAL IN-LINE | CLOSE-COUPLED

- The Armstrong 4360 pipe-mounted pumps are designed for space-saving installation and long service life
- Up to 350 USgpm flow; up to 200 ft head
- Temperature: 225°F
- Power: 0.33 hp to 15 hp
- Size: 1¼" to 3"



4360 VERTICAL IN-LINE PUMPS

HORIZONTAL

- Reduces cost across installation, operation, and lifetime maintenance. High-efficiency NEMA-premium motors ensure low energy consumption and cost
- Up to 5000 USgpm flow; up to 600 ft head
- Temperature: 250°F
- Power: 0.33 hp to 300 hp

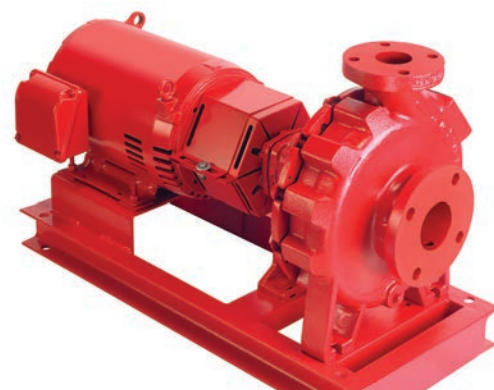

4030 END SUCTION BASE MOUNTED PUMPS

- Pipe-mounted pumps designed for space-saving installation; available for express shipment, typically within 48 hours
- Up to 175 USgpm flow; up to 90 ft head
- Temperature: 225°F
- Power: 0½ hp to 3 hp
- Size: 1¼" to 3"

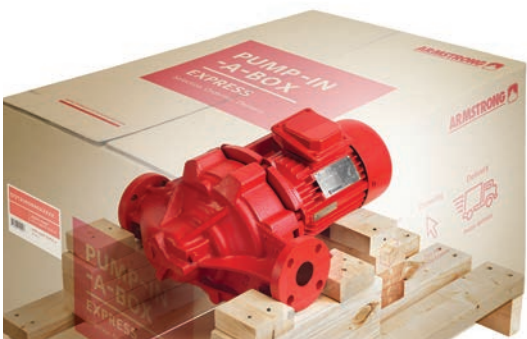

4360 PUMP-IN-A-BOX

- End-suction pumps equipped with close-coupled motors to minimize footprint requirements
- Up to 2000 USgpm flow; up to 400 ft head
- Temperature: 250°F
- Power: 0.33 hp to 60 hp
- Size: 1" to 6"

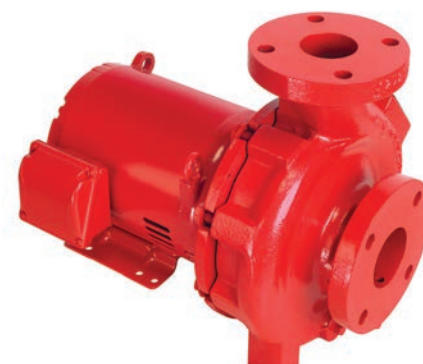

4280 MOTOR MOUNTED PUMPS

- Pipe-mounted pumps designed for space-saving installation and long service life; available for express shipment, typically within 48 hours
- Up to 450 USgpm flow; up to 90 ft head
- Temperature: 250°F
- Power: 1 hp to 7½ hp
- Size: 1½" to 4"

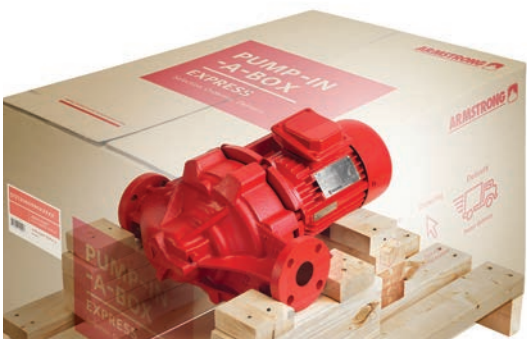

4380 PUMP-IN-A-BOX

- Close coupled horizontal pumps, motor mounted and designed for long service life and easy maintenance
- Up to 3600 USgpm flow; up to 130 ft head
- Temperature: 275°F
- Power: 0.33 hp to 60 hp
- Size: 1¼", 1½", 2"



4270 & 4270 STOCK MOTOR MOUNTED PUMPS

COMMERCIAL PUMPS

VERTICAL IN-LINE | SPLIT-COUPLED

- designed for reliability and low maintenance cost
- Up to 400 USgpm flow; up to 900 ft head
- Temperature: 250°F
- Power: 0½ hp to 50 hp
- Size: 1¼" to 4"



4700 VERTICAL MULTISTAGE PUMPS

HORIZONTAL

- Engineered to reduce cost across installation, operation, and lifetime maintenance. High-efficiency NEMA-premium motors ensure low energy consumption and cost
- Up to 7000 USgpm flow; up to 600 ft head
- Temperature: 225°F
- Power: 1½ hp to 500 hp

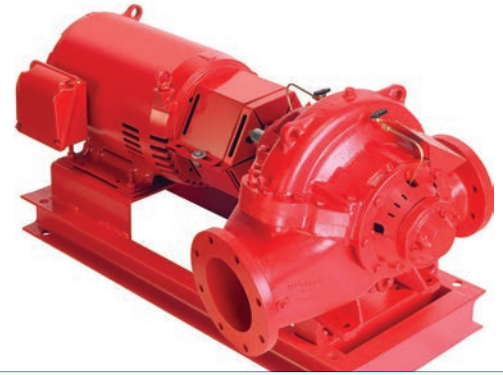

4600 HORIZONTAL SPLIT-CASE PUMPS

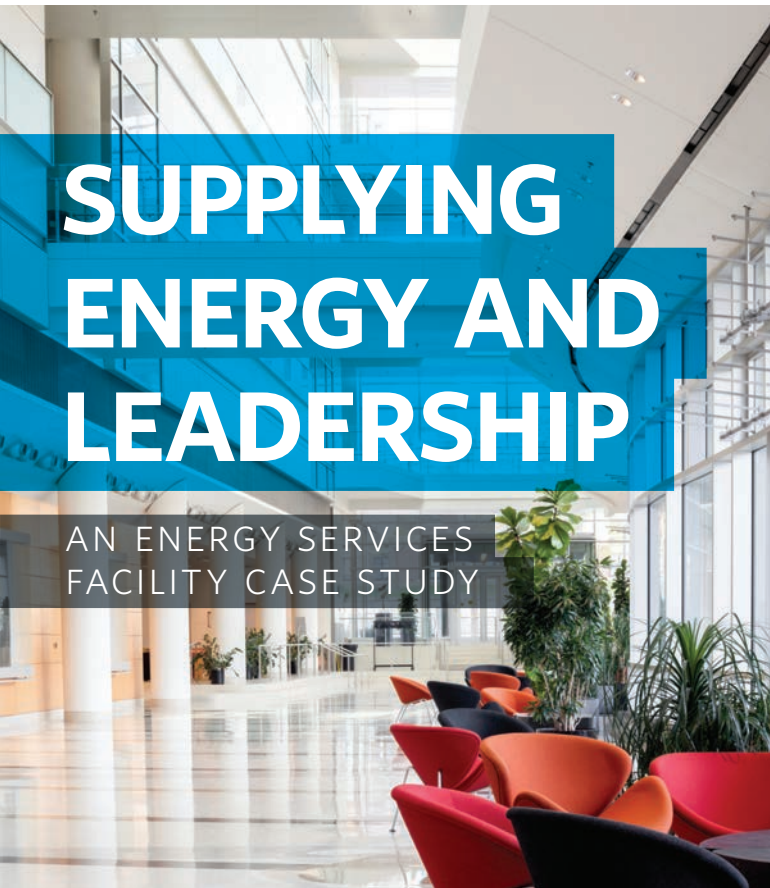

SUPPLYING ENERGY AND LEADERSHIP

AN ENERGY SERVICES FACILITY CASE STUDY

Florida Power & Light

As a result of upgrading their existing HVAC system, Florida Power & Light have reduced the energy costs for pumps by

68%

saving thousands of dollars per year.

Armstrong Design Envelope pumps operate at variable speed to provide comfort cooling in response to demand. Design Envelope technology, combined with advanced control features make this an industry-leading solution.



Scan to learn more about this case study

LIGHT COMMERCIAL & RESIDENTIAL PUMPS

The Armstrong Design Envelope Compass circulator embeds the latest motor and control technologies, providing you with the ultimate in flexibility, operating comfort, and energy efficiency. Our broad offering of wet-rotor and dry-rotor designs help you respond to any hydronic situation with ease and confidence.

WET ROTOR DESIGN

- Designed to replace existing fixed speed circulators, with popular flange-to-flange dimensions. A universal replacement for all circulators in its capacity range
- Cast iron and stainless steel volutes
- Up to 20 USgpm flow; up to 20 ft head
- Power: 5W to 45W

DESIGN ENVELOPE COMPASS H CIRCULATOR



DRY ROTOR DESIGN

- Designed to replace existing fixed speed circulators, with popular flange-to-flange dimensions. A universal replacement for all circulators in its capacity range
- Cast iron and stainless steel volutes
- Up to 75 USgpm flow; up to 20 ft head
- Power: ¼ hp

DESIGN ENVELOPE COMPASS R CIRCULATOR



- Designed for quiet operation and zero maintenance. In combination with cast iron volutes, the Astro 2 line is intended to circulate water or ethylene-glycol solutions in closed hydronic or solar heating systems.
- Up to 64 USgpm flow; up to 42 ft head
- Power: 33W to 218W

ASTRO 2 CIRCULATORS



- Draws on advanced motor technology and efficient hydraulic design to achieve excellent wire-to-water duty point efficiencies
- Up to 140 USgpm flow; up to 60 ft head
- Temperature: 110°F
- Power: ¼ hp to ¾ hp
- Size: .¾" to 3"

E.2 CIRCULATORS



- Circulates water or ethylene-glycol solutions in closed hydronic or solar heating systems. Available in three volute materials for residential, small industrial, and commercial applications
- Up to 64 USgpm flow; up to 42 ft head
- Power: 33W to 218W

ASTRO 2 HOT WATER RECIRCULATION SYSTEM



- For commercial systems that require higher flow and pressure. Offers the flexibility of customizing the flow curve to specific application requirements
- Up to 250 USgpm flow; up to 55 ft head
- Temperature: 107°F
- Power: ¼ hp to 3 hp
- Size: ¾", to 2"

S&H 3-PIECE CIRCULATORS



LIGHT COMMERCIAL & RESIDENTIAL PUMPS

DRY ROTOR DESIGN

- A complete repair solution for the s&H circulator line. Armstrong PLVs can also be used to rebuild or upgrade select ITT/B&G circulator models
- Up to 120 USgpm flow; up to 60 ft head
- Temperature: 29°F
- Power: 1/2 hp to 2 hp



S&H CIRCULATOR
LESS VOLUTE

WET ROTOR DESIGN

- A combination of circulator and low-flow (LF) valve that provides instant hot water in a residential plumbing system
- Up to 9 1/2 USgpm flow; up to 6 ft head
- Temperature: 40°F
- Power: 33W
- Size: 1 1/2" union



ASTRO EXPRESS 2 HOT
WATER RECIRCULATION
SYSTEM

- For commercial systems that require higher flow and pressure. Offers the flexibility of customizing the flow curve to specific application requirements
- Up to 250 USgpm flow; up to 55 ft head
- Temperature: 107°F
- Power: 1/4 hp to 3 hp
- Size: 3/4" to 3"



1050/1060, 3-PIECE
CIRCULATORS

REPLACEMENT PARTS



Even the best equipment and installations require attention from time to time.

Genuine factory parts keep your Armstrong equipment and systems operating reliably with a long service life — the way they were originally designed for. Our upgraded maintenance-free bearing assemblies also work as replacement parts for other makes. Call our Field Assistance at +1 416 755 2298 or your local authorized Armstrong Service Dealer.

SUMP & SEWAGE PUMPS

Armstrong sump and sewage equipment affords you reliable and long-lasting performance. Plus, you can choose from a variety of options, configurations and accessories.

- Designed for use in light to heavy duty commercial environments
- Up to 700 USgpm flow; up to 100 ft head

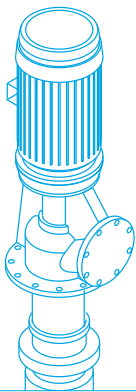

**5200 & 5240
COLUMN SUMP PUMPS**

- Designed for flexible configuration, superior reliability, and easy maintenance in tough building, municipal, and industrial environments
- Capable of handling waste material and sewage with solids of sizes up to 2½"; depths over 5 ft

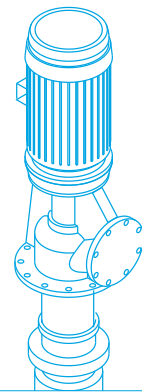

**5400 COLUMN
SEWAGE PUMPS**

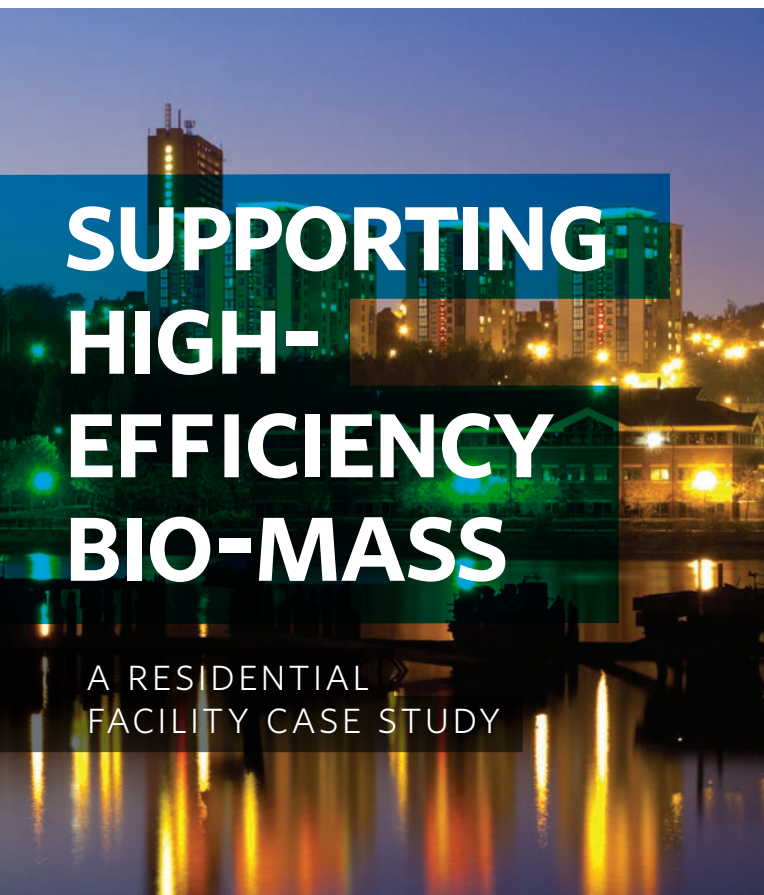

**SUPPORTING
HIGH-
EFFICIENCY
BIO-MASS**

A RESIDENTIAL
FACILITY CASE STUDY

Riverside Dene Estate

The new district heating system is expected to provide consistent and reliable delivery of heat to local residents in addition to reducing heating costs and cutting CO₂ emissions by over

1000

tonnes per year.

Vital Energi needed pumping capacity to support a sustainable district heating scheme at Riverside Dene Estate. Armstrong delivered an intelligent Fluid Management System (iFMS), including Design Envelope pumps with integrated controls.



Scan to learn more about this case study

FIRE PUMPS & PACKAGES

When it comes to fire protection you can count on our track record of delivering reliable, durable and easy to test equipment and systems that are up to this critical task. Armstrong fire pumps and packages are constructed, tested and certified to the strictest global standards including NFPA, UL, ULC, and FM.

FIRE PACKAGES

- Available as single electric, single diesel, one electric plus one diesel, two electric, or two diesel configurations. Optional features include tamper switches, test header lines, city by-pass and flow meter loops with all required piping and valves

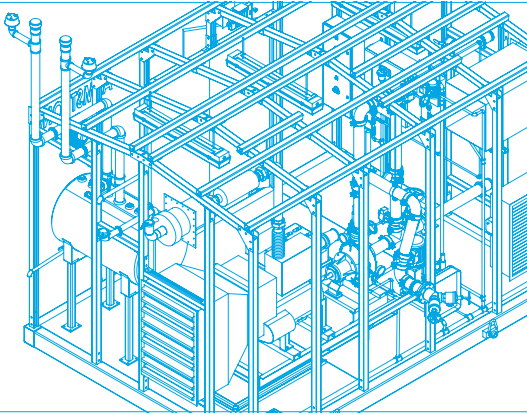

ENCLOSED FIRE PUMP PACKAGES

- Features the full range of Armstrong hsc fire pumps, electric or diesel-driven, and controller. All mounted, piped, and wired on a base at the factory
- Up to 3000 USgpm



FIREPAK HORIZONTAL SPLIT CASE

- Features the full range of vIL fire pumps with electric motor and controller. All mounted, piped, and wired on a base at the factory. The complete package is designed to fit through a standard door
- Up to 1500 USgpm



FIREPAK VERTICAL IN-LINE

FIRE PUMPS

- Deploys a heavy-duty bearing frame to provide long and reliable service in an over-hung impeller design. Eliminates the design layout constraints imposed by horizontal split-case pump configurations
- Up to 1750 USgpm

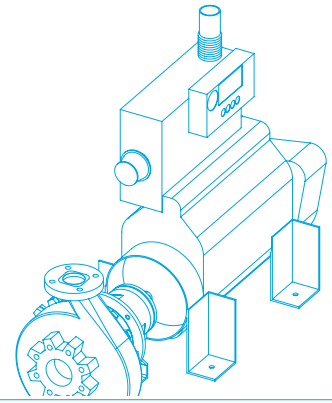

FIRESET END SUCTION DIESEL & ELECTRIC

- Deploys a tilted parting design, with the casing of each pump split at a 15° angle. This maximizes efficiency by minimizing turbulence at the impeller eye
- Up to 3000 USgpm

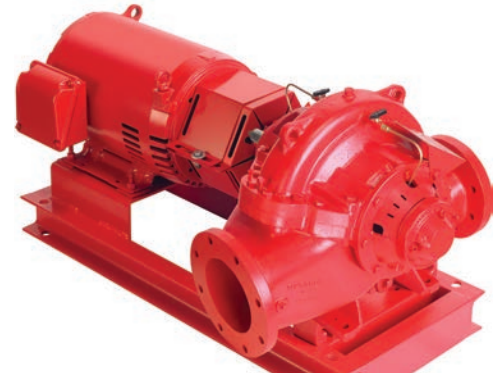

FIRESET HORIZONTAL SPLIT CASE DIESEL & ELECTRIC

- Ideal for applications where space is at a premium. The vertical in-line design saves up to 60% of floor space compared to equivalent horizontal split-case installations
- Up to 1500 USgpm



FIRESET VERTICAL IN-LINE

FIRE PUMPS & PACKAGES

FIRE PUMPS

- Designed for reliability and low maintenance cost
- Up to 400 USgpm flow; up to 900 ft head
- Temperature: 250°F
- Power: ½ hp to 50 hp
- Size: 1½", to 4"



4700 VERTICAL MULTI-STAGE PUMPS



CLIMATE CONTROL & EXTRA CARGO SPACE

A COMMERCIAL FACILITY CASE STUDY

Nissan, USA Corporate Headquarters

Through the Design Assist service, Armstrong was able to optimize the mechanical room layout and save almost

\$70,000

in piping costs.

The Armstrong Integrated Plant Controller (IPC) 11550 is a chilled-water plant automation system designed to provide industry-leading energy efficiency as well as improved occupant comfort through all-variable-speed operation.



Scan to learn more about this case study



Your partner in building performance
from concept through ongoing life
cycle optimization

IDENTIFY

Your scenario

starting with a set of real-world HVAC configurations detailed in our new Application Guides.

The configurations included in these guides embody 80 years of expertise and proven results.

SECURE

Your success

through performance management services that augment our expertise in assessing, designing and installing your system.

BUILD

Your solution

from an integrated suite of high-performance Design Envelope solutions delivering:

- Lowest installed cost
- Lowest lifecycle cost
- Lowest project & operating risk
- Lowest environmental impact



WHERE TO BUY

Armstrong products, services, and replacement parts are available nationwide from our authorized representatives, distributors, wholesalers, and service dealers.

Visit ArmstrongFluidTechnology.com to find your local representative



WHY USE VERTICAL INLINE (VIL) PUMPS VS. HORIZONTAL DESIGN?

HORIZONTAL DESIGN

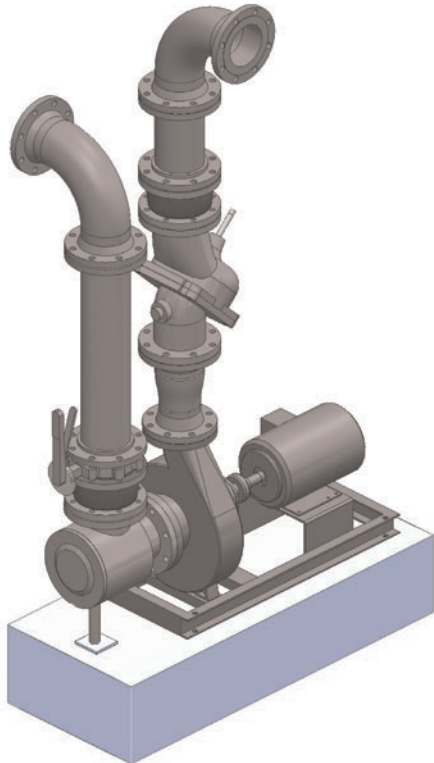

VERTICAL INLINE

Reduced footprint (typically 46% of equivalent horizontal design)

No requirement for concrete pad

No requirement for isolation mount and springs

No requirement for axle alignment after seal change (VIL is self-aligning)

Rapid seal changes (typical 20 minutes with one person)

Ultra-smooth operation with minimal vibration

Reduced pipe runs

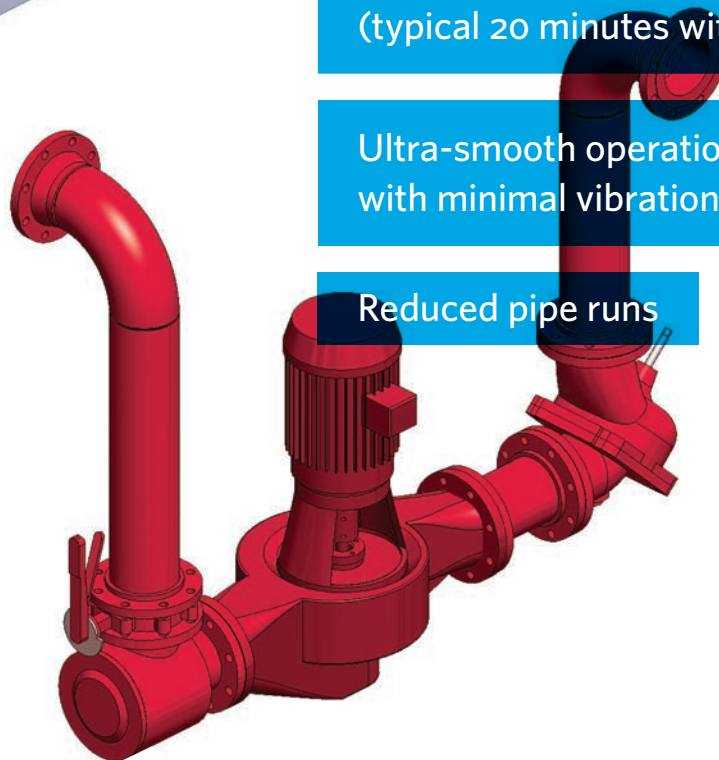

WHY USE DESIGN ENVELOPE INTEGRATED CONTROLS VS. WALL-MOUNTED DRIVES?

WALL-MOUNTED DRIVE

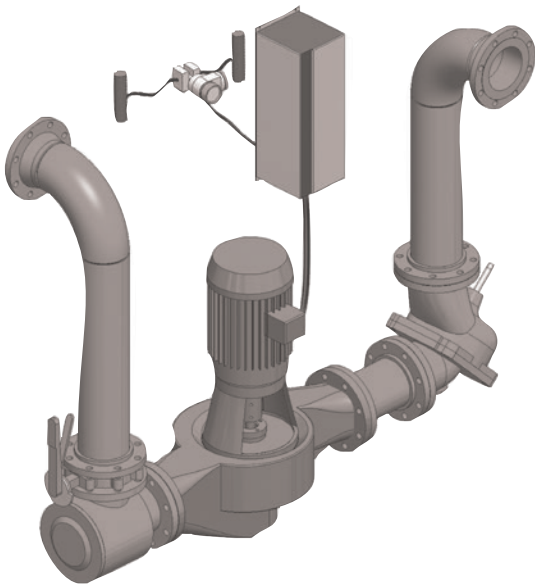

DESIGN ENVELOPE INTEGRATED CONTROLS

Minimal project and operating risk through three-year warranty on controls and pump

Single point of supplier accountability

Factory tested and configured

Superior energy efficiency and envelope control compared to “non-native” controls (such as wall-mounted drives)

Integrated 5% line isolation (no need for separate transformer)

Elimination of grounding rings (optional in case of concern)

Outdoor option up to 125 HP (no enclosure required)

Elimination of wiring (power and control) between pump and wall-mounted drive

Elimination of differential-pressure sensor as well as associated wiring and labor (in case of concern Design Envelope can read sensor input)

DESIGN ENVELOPE

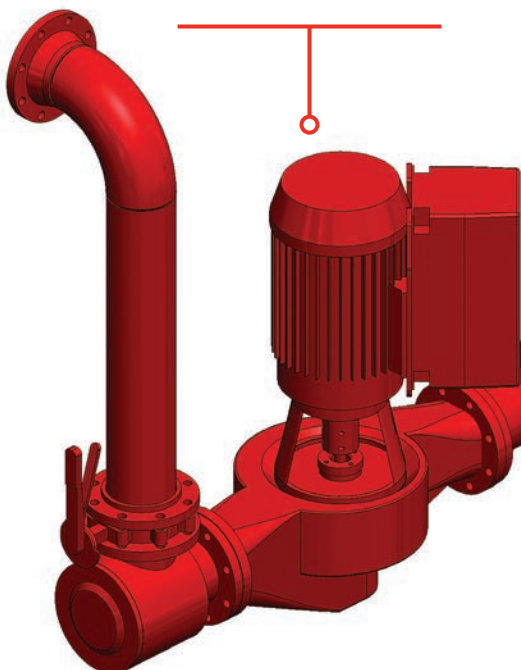

What makes Armstrong different?

No other company integrates demand-based controls, heat transfer, fluid flow and variable speed as well as Armstrong, adding value to your project.

Only Armstrong has patented, award-winning, proprietary Parallel Sensorless pumping technology, delivering unmatched efficiency with multiple pumps.

Armstrong's integrated capability offers unmatched scalability and flexibility, opening up significant application opportunities.

Only Armstrong offers intelligent, self-aware and self-optimizing solutions that combine to deliver optimum building performance.

Only Armstrong can deliver both the lowest installed cost AND the lowest operating cost time after time.

Only Armstrong factory tests and programs each unit, resulting in the accuracy and repeatability of all our solutions from custom large plants to small components.

Armstrong is privately held, allowing us to take a long-term perspective on the success of your project.

TORONTO

23 BERTRAND AVENUE
TORONTO, ONTARIO
CANADA
M1L 2P3
+1 416 755 2291

BUFFALO

93 EAST AVENUE
NORTH TONAWANDA, NEW YORK
U.S.A.
14120-6594
+1 716 693 8813

BIRMINGHAM

HEYWOOD WHARF, MUCKLOW HILL
HALESOWEN, WEST MIDLANDS
UNITED KINGDOM
B62 8DJ
+44 (0) 8444 145 145

MANCHESTER

WOLVERTON STREET
MANCHESTER
UNITED KINGDOM
M11 2ET
+44 (0) 8444 145 145

BANGALORE

#59, FIRST FLOOR, 3RD MAIN
MARGOSA ROAD, MALLESWARAM
BANGALORE, INDIA
560 003
+91 (0) 80 4906 3555

SHANGHAI

UNIT 903, 888 NORTH SICHUAN RD.
HONGKOU DISTRICT, SHANGHAI
CHINA
200085
+86 (0) 21 5237 0909

SÃO PAULO

RUA JOSÉ SEMIÃO RODRIGUES AGOSTINHO,
1370 GALPÃO 6
EMBU DAS ARTES
SAO PAULO, BRAZIL
+55 11 4785 1330



For more information, contact your
Armstrong representative or visit us at
ArmstrongFluidTechnology.com/ContactUs



Scan for
more details
online

**MAKING
ENERGY
MAKE
SENSE™**