

# San Ace 60L <sup>9CRLA type</sup>

## High Static Pressure Long Life Counter Rotating Fan

### Features

#### High Static Pressure

This fan delivers a maximum airflow of 2.1 m<sup>3</sup>/min and maximum static pressure of 1,400 Pa. The maximum static pressure has increased by approximately 40% compared with our current model.\*

#### Long Service Life

With an expected life of 100,000 hours (about 11 years) of continuous operation, this fan contributes to longer maintenance-free operating periods for devices.

#### High Energy Efficiency and Low Noise

The PWM control function enables the external control of fan speed, contributing to lowering noise and improving energy efficiency of devices.

\* The San Ace 60L 9CRL type 60 x 60 x 76 mm Long Life Counter Rotating Fan (model no.: 9CRL0612P0G001).



## 60 x 60 x 76 mm

### Specifications

The models listed below **have pulse sensors with PWM control function.**

Model no.	Rated voltage [V]	Operating voltage range [V]	PWM duty cycle* [%]	Rated current [A]	Rated input [W]	Rated speed [min <sup>-1</sup> ]		Max. airflow [m <sup>3</sup> /min] [CFM]		Max. static pressure [Pa] [inchH <sub>2</sub> O]		SPL [dB(A)]	Operating temperature [°C]	Expected life [h]
						Inlet	Outlet	Inlet	Outlet	[Pa]	[inchH <sub>2</sub> O]			
9CRLA0612P0G001	12	10.8 to 13.2	100	3.0	36.0	16500	17800	2.1	74.1	1400	5.62	70	-20 to +70	100000/60°C
			20	0.4	4.8	5000	5400	0.64	22.6	128	0.51	43		
9CRLA0612P0G003			100	3.0	36.0	16500	17800	2.1	74.1	1400	5.62	70		
			20	0.4	4.8	5000	5400	0.64	22.6	128	0.51	43		

\* PWM frequency: 25 kHz. Fan does not rotate when PWM duty cycle is 0%.

Models with the following sensor specifications are also available as options: **Without sensor** **Lock sensor**

### Common Specifications

- Material ..... Frame: Aluminum (Black coating), Impeller: Plastic (Flammability: UL 94V-1)
- Expected life ..... Refer to specifications  
(L10 life: 90% survival rate for continuous operation in free air at 60°C, rated voltage)
- Motor protection system ..... Current blocking function and reverse polarity protection
- Dielectric strength ..... 50/60 Hz, 500 VAC, for 1 minute (between lead wire conductors and frame)
- Sound pressure level (SPL) ..... At 1 m away from the air inlet
- Operating temperature ..... Refer to specifications (Non-condensing)
- Storage temperature ..... -30 to +70°C (Non-condensing)
- Lead wire ..... Inlet: ⊕ Red ⊖ Black [Sensor] Yellow [Control] Brown  
Outlet: ⊕ Orange ⊖ Gray [Sensor] Purple [Control] White
- Mass ..... Approx. 310 g

### Airflow - Static Pressure Characteristics

• PWM duty cycle

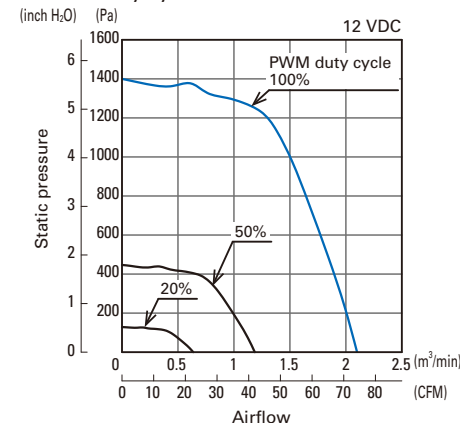

9CRLA0612P0G001  
9CRLA0612P0G003

• Operating voltage range

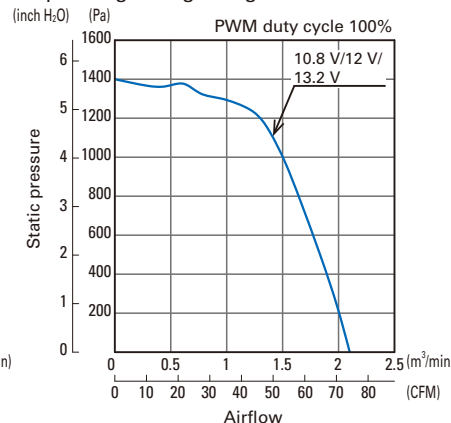

9CRLA0612P0G001  
9CRLA0612P0G003

### PWM Duty - Speed Characteristics Example

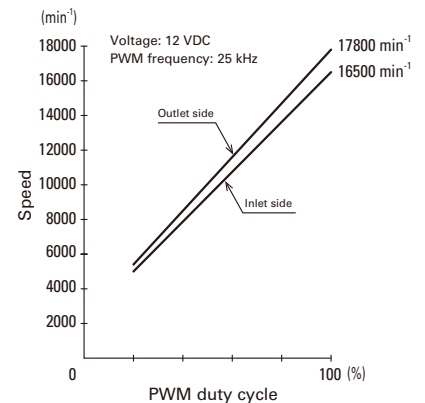

9CRLA0612P0G001  
9CRLA0612P0G003

## PWM Input Signal Example

Input signal waveform

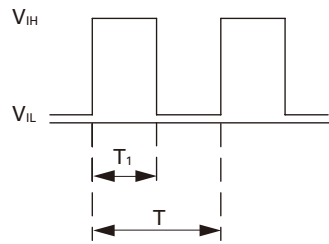

$V_{IH} = 4.75 \text{ to } 5.25 \text{ V}$   $V_{IL} = 0 \text{ to } 0.4 \text{ V}$   
 PWM duty cycle (%) =  $\frac{T_1}{T} \times 100$  PWM frequency 25 (kHz) =  $\frac{1}{T}$   
 Current source ( $I_{source}$ ) = 5 mA max. (when control voltage is 0 V)  
 Current sink ( $I_{sink}$ ) = 5 mA max. (when control voltage is 5.25 V)  
 Control terminal voltage = 5.25 V max. (when control terminal is open)

When the control terminal is open,  
 fan speed is the same as when PWM duty cycle is 100%.  
 Either TTL input, open collector or open drain can be used for  
 PWM control input signal.

## Example of Connection Schematic

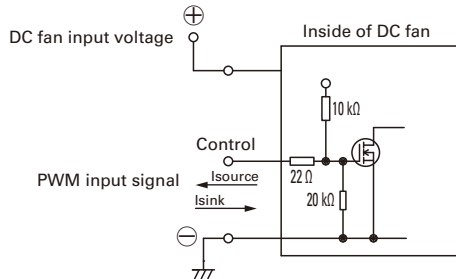

## Specifications for Pulse Sensors

Output circuit: Open collector

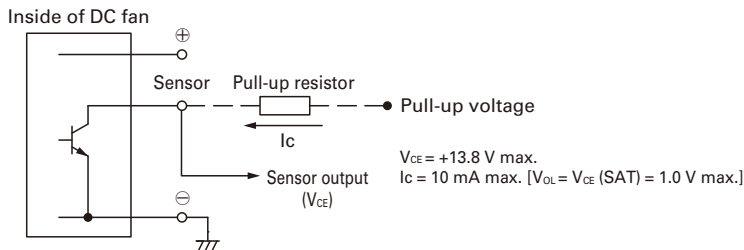

Output waveform (Need pull-up resistor)

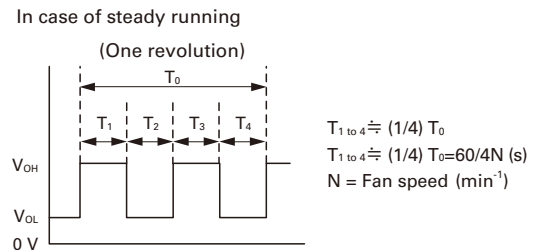

## Dimensions (unit: mm)

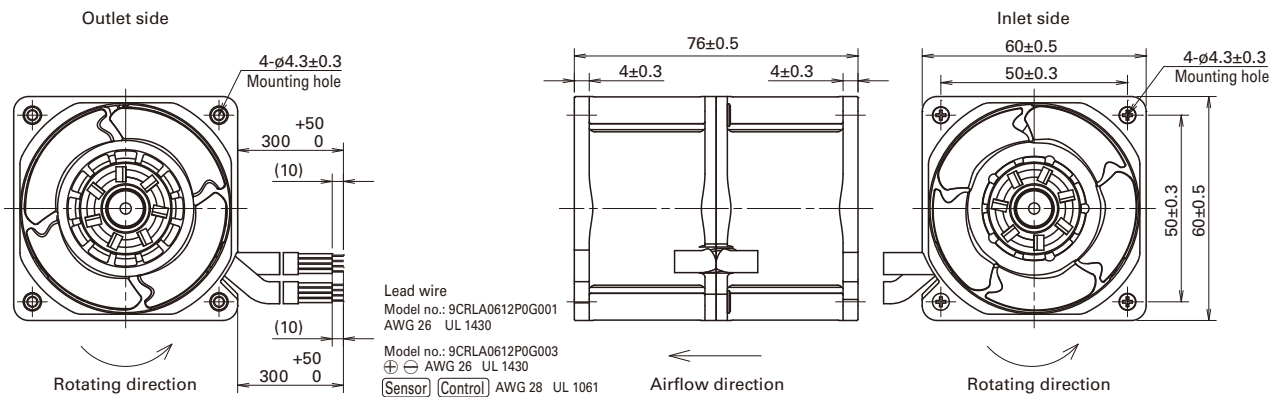

## Reference Dimensions of Mounting Holes and Vent Opening (unit: mm)

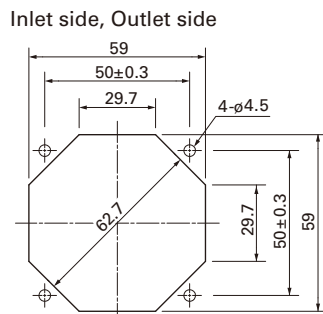

### Notice

- Please read the "Safety Precautions" on our website before using the product.
- The products shown in this catalog are subject to Japanese Export Control Law. Diversion contrary to the law of exporting country is prohibited.
- For protecting fan bearings against electrolytic corrosion near strong electromagnetic noise sources, we provide effective countermeasures such as Electrolytic Corrosion Proof Fans and EMC guards. Contact us for details.