



Features

- Terminal preventing losing screw
- Two type of inductance coil is available: F means Ferrite H means High μ
- The capacitance of Y cap is selectable
- DIN rail type is option

Applications

- Medical devices, Information processing devices, Office appliances, and Various control systems



- DIN rail type (option)



Safety Standard	File No.
UL :UL-1283	E78644
cUL :CSA C22.2 No.8	
ENEC :EN60939-3	SE-ENEC-2201373

The "ENEC" mark is a common European product certification mark based on testing to harmonised European safety standard.
*File No. may be revised without notice. Please contact us at the time of your request for certifications.

- Model numbering system

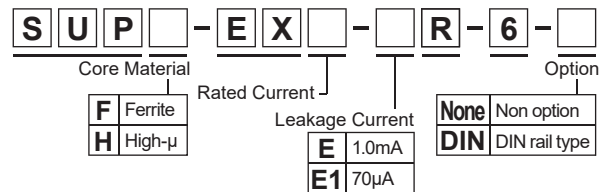

- Dimensions

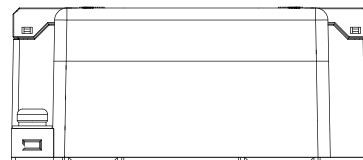
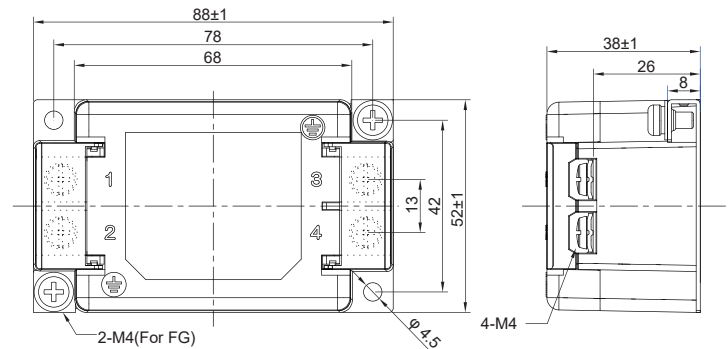

Tolerances: \pm 0.5
Unit: mm

- Circuit

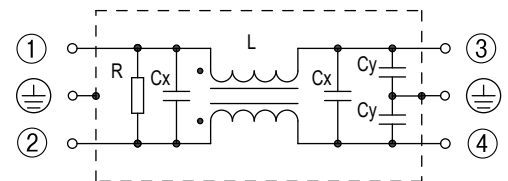

Electrical Specifications

Rated Voltage **250Vac**

Safety Standard	Model Number	Rated Current (A)	Test Voltage	Insulation Resistance	Leakage Current max.	Voltage Drop max.	Temperature Rise max.	Operating Temperature (°C)	Weight typ.(g)
	SUP□-EX5-ER-6	5	Line to Line 1,000Vac 50/60Hz 60sec	Line to Ground 300M Ω min (at 500Vdc)	1.0mA (at 250Vac, 60Hz)	1.0Vac	45K	-25 ~ +55 (100°C with Temp. rise)	210
	SUP□-EX10-ER-6	10							
	SUP□-EX15-ER-6	15							
	SUP□-EX20-ER-6	20							
	SUP□-EX30-ER-6	30	Line to Ground 3,000Vac 50/60Hz 60sec		70 μ A (at 250Vac, 60Hz)				
	SUP□-EX5-E1R-6	5							
	SUP□-EX10-E1R-6	10							
	SUP□-EX15-E1R-6	15							
SUP□-EX20-E1R-6	20								
SUP□-EX30-E1R-6	30								

□= F: Ferrite, H: High- μ

● *Static characteristics (Representative example)*

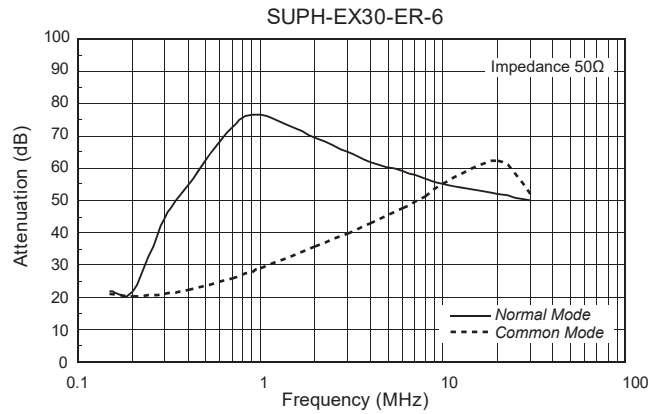
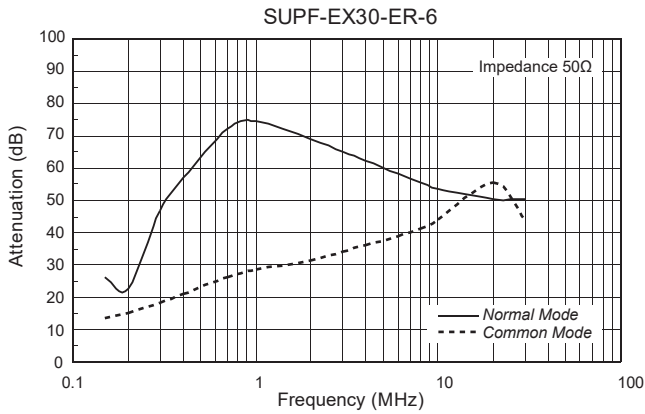
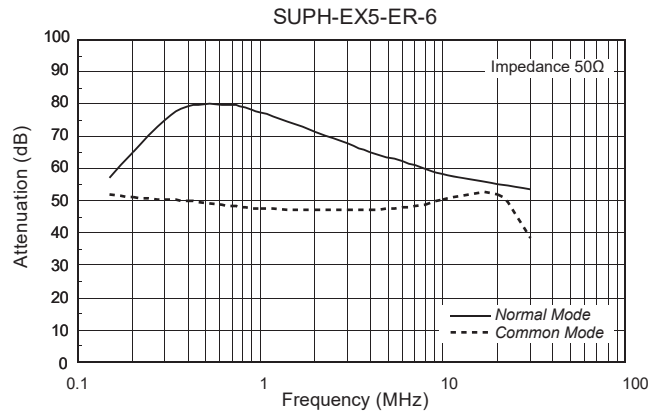
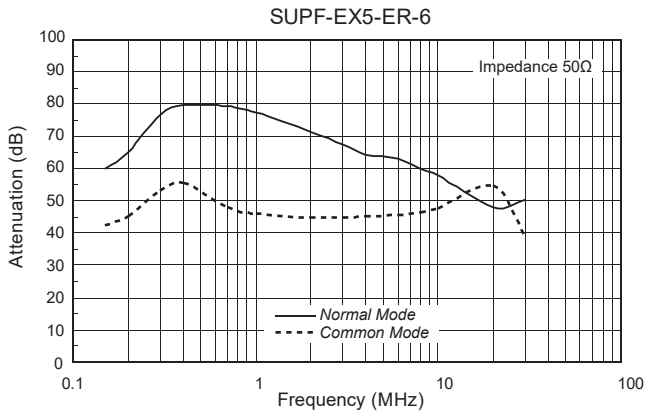

● *Dimensions*

DIN rail type (option)

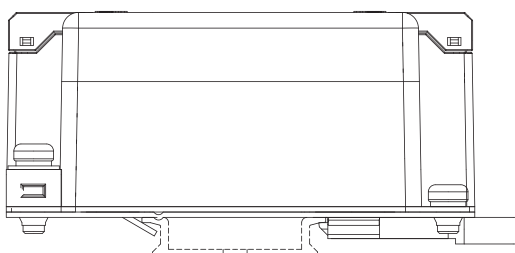
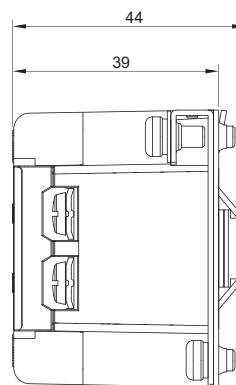
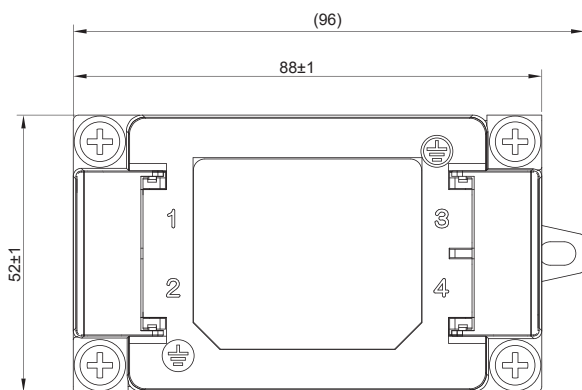

● *Note when installing EMI filter on DIN rail*

Even though the ground connects correctly through the DIN rail, may not get noise attenuation. Be sure to connect the FG ground of EMI filter to the ground directory.

Tolerances: ±1.5
Unit: mm